

# Price List

## Aeris Swopper

The Aeris Swopper prices are determined by the type of footring (glides or castors) and the different seat covers.

Seat cover	Aeris Swopper with glides Recommended retail price in EUR excl. VAT	Aeris Swopper with castors Recommended retail price in EUR excl. VAT
Artificial leather (Uruguay, Elastron)	€ 553.78	€ 587.39
Recycled Post-Consumer Polyester (Cura, Gabriel)	€ 570.59	€ 604.20
Wool blend (Capture, Gabriel)	€ 578.99	€ 612.61
Wool blend (Select, Gabriel)	€ 578.99	€ 612.61
Artificial leather (Mediflex, Monteiro)	€ 578.99	€ 612.61
Microfibre (Comfort, Gabriel)	€ 587.39	€ 621.01
Mesh fabric Runner (Gabriel)*	€ 587.39	€ 621.01
Leather (Atlantic, Heller-Leder)	€ 671.43	€ 705.04

\* Swopper Air: Seat (multi-layer structure)

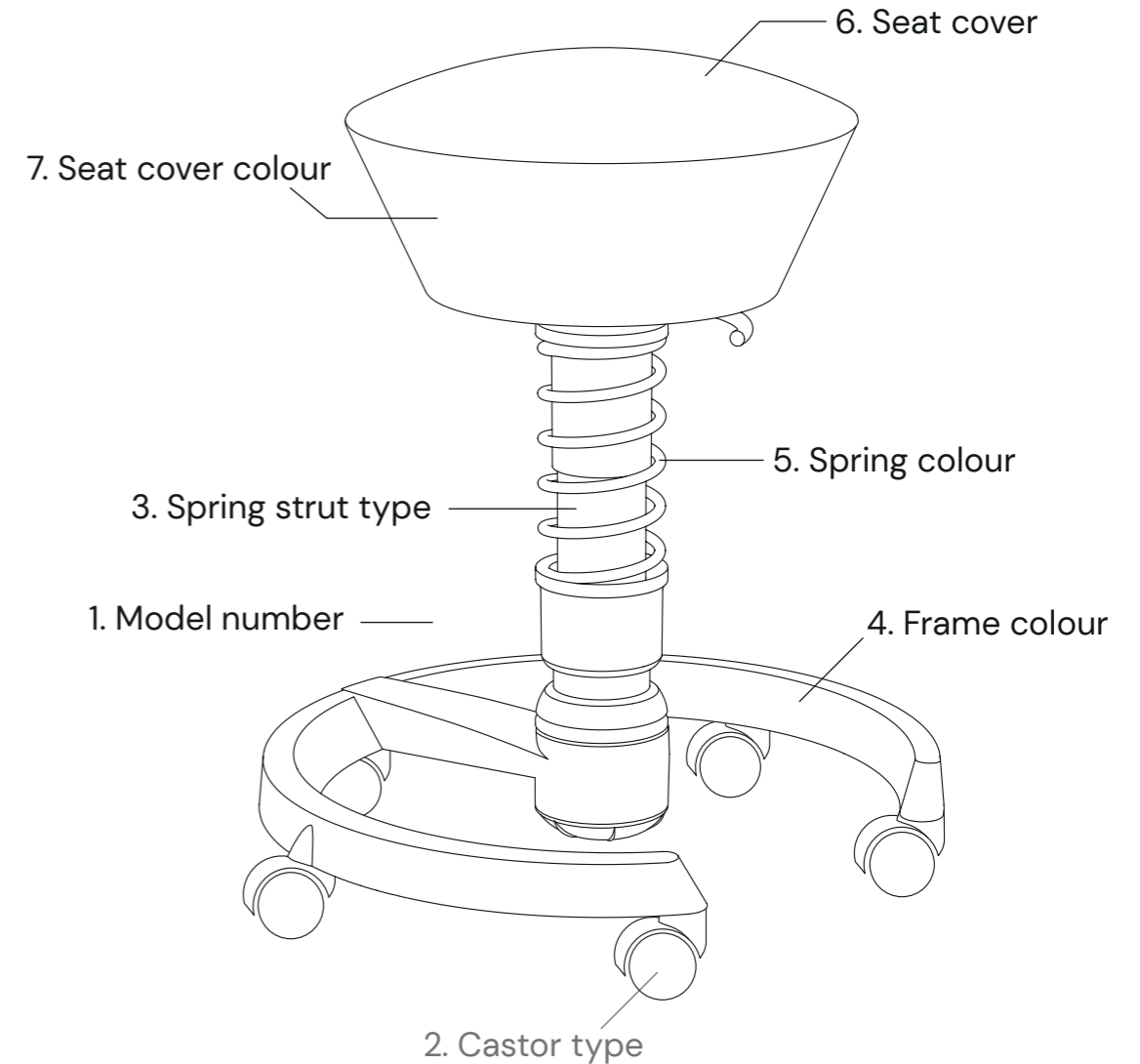

# Components of the Aeris Swopper article number easily explained.

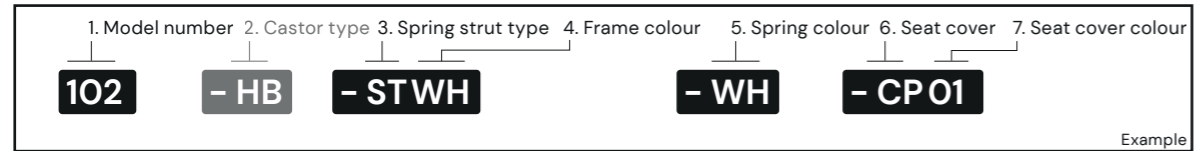

1. Model number	Article code
Glides	101
Castors	102

2. Castor type (only for model 102 with castors)	Article code
Hard floor castors (tiles, parquet, laminate or similar)	- HB
Soft floor castors (carpet, PVC, felt or similar)	- WB

3. Spring strut type	Article code
<b>Standard:</b> Body weight: 50 - 120 kg Height adjustment range under load: 45 - 59 cm Height adjustment range without load: 52 - 66 cm	- ST
<b>Low:</b> Body weight: 50 - 120kg Height adjustment range under load: 42 - 56 cm Height adjustment range without load: 50 - 64 cm	- LO
<b>High:*</b> Body weight: 50 - 120kg Height adjustment range under load: 49 - 69 cm Height adjustment range without load: 56 - 76 cm	- HI
<b>Light:</b> Body weight: 35 - 50kg Height adjustment range under load: 42 - 56 cm Height adjustment range without load: 47 - 61 cm	- LI

\* Available only for Aeris Swopper with glides.

4. Frame colour	Article code
white	WH
black	BK

5. Spring colour*	Article code
white	- WH
black	- BK

\* Spring colour same as the frame colour (white, black).

6. Seat cover	Article code
Artificial leather (Uruguay, Elastron)	- UR
Recycled Post-Consumer Polyester (Cura, Gabriel)	- CU
Wool blend (Capture, Gabriel)	- CP
Wool blend (Select, Gabriel)	- SE
Artificial leather (Mediflex, Monteiro)	- ME
Microfibre (Comfort, Gabriel)	- CM
Mesh fabric (Runner, Gabriel)	- RN
Leather (Atlantic, Heller-Leder)	- LA

## 7. Seat cover colour

Please first select the seat cover colour for the Aeris Swopper. The relevant article code (Aeris colour code) can be found on the following pages. Simply put it behind the article code of the seat cover (without hyphen).

# Aeris Swopper Fabric sample overview

Capture / Gabriel

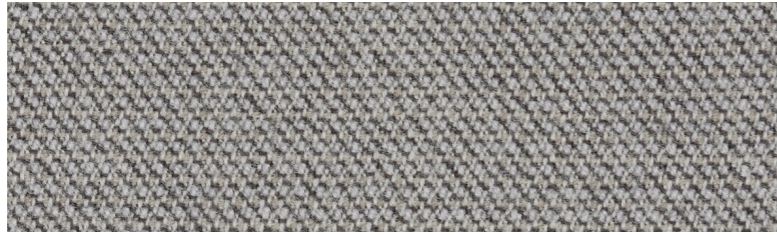

Select / Gabriel



CP01, black  
melange  
5501

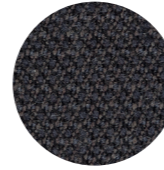

CP05, green  
melange  
5301

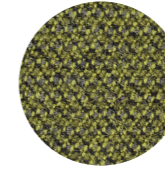

CP22, stone grey  
melange  
4102

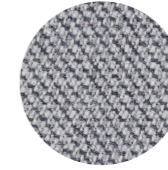

CP24, slate grey  
melange  
4601

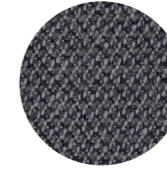

CP26, pigeon blue  
melange  
4902

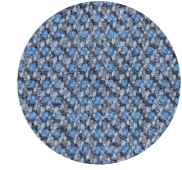

CP28, petrol blue  
melange  
5001

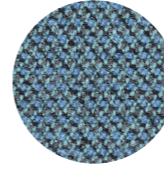

CP29, dark red  
melange  
5402

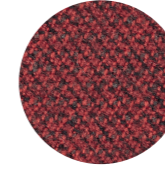

CP30, orange-red  
melange  
4301

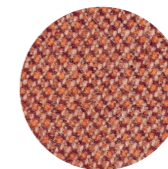

CP31, pink-red  
melange  
4802

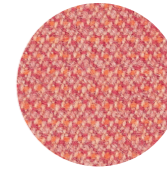

CP35, green-beige  
melange  
5101

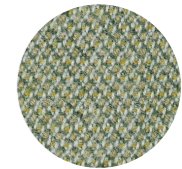

SE01, black  
60999



SE02, grey  
60130



SE03, red  
64089

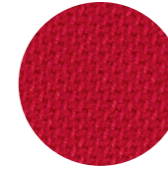

SE04, blue  
66071

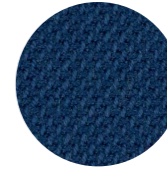

SE05, green  
67095

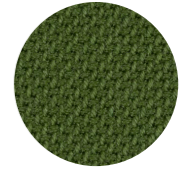

SE07, slate grey  
60134

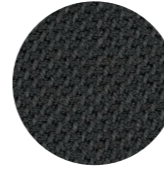

SE10, pastel blue  
67098

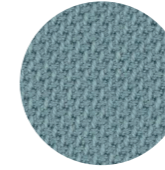

SE11, azure blue  
66192

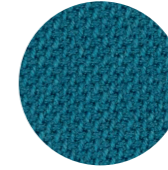

SE15, pale pink  
65117

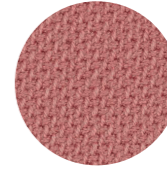

SE19, turquoise  
67100

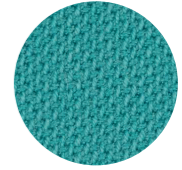

# Aeris Swopper Fabric sample overview

Cura / Gabriel

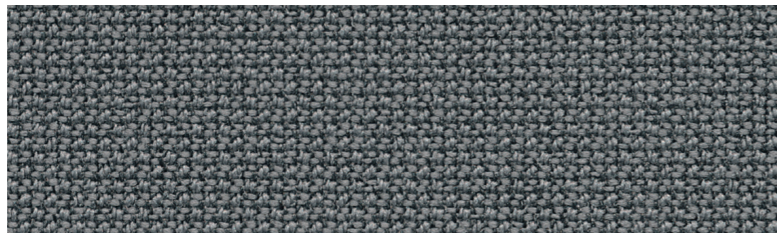

Comfort / Gabriel



Runner / Gabriel



CU01, black

60111

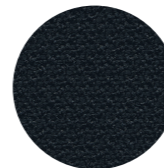

CU02, grey  
melange

60110

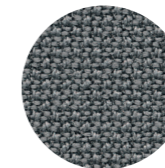

CU04, blue  
melange

66167

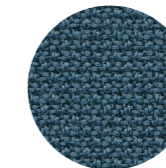

CU06, yellow  
melange

62084

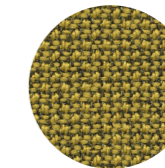

CU09, light violet  
melange

64194

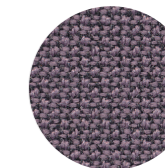

CU12, petrol blue  
melange

67084

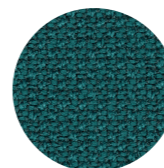

CU13, pale green  
melange

68186

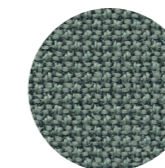

CU14, fern green  
melange

68181

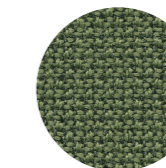

CU16, beige  
melange

61168

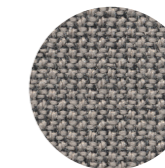

CU17, light grey  
melange

60112

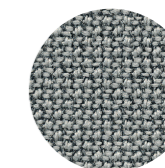

CM01, black

0050

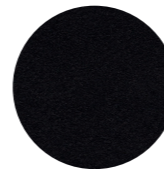

CM02, grey

1012

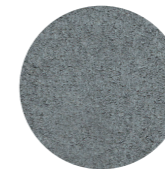

CM03, red

1414

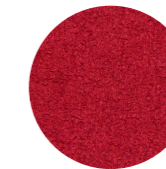

CM04, blue

66004

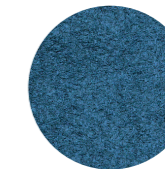

CM05, green

8397

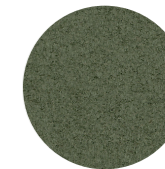

RN01, black

60999

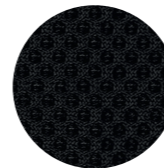

RN02, grey

60011

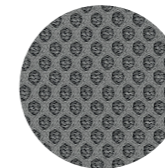

RN03, red

64119

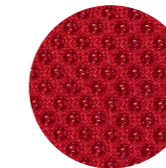

RN04, blue

66123

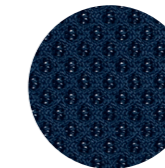

RN05, green

68110

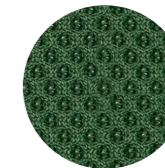

# Aeris Swopper Fabric sample overview

Uruguay / Elastron

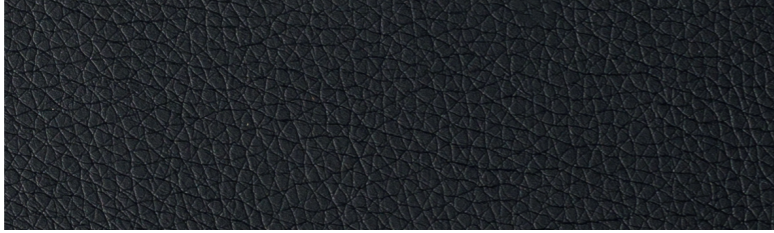

UR01, black  
13-901



Mediflex / Monteiro



ME01, black  
67796

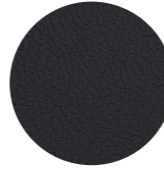

Atlantic / Heller-Leder

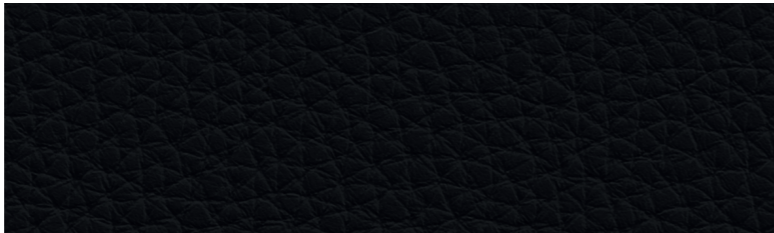

LA01, black  
35002 999



## Gabriel Capture features

The use of lightly felted, multicolored wool in this material gives it a unique and appealing texture. The sophisticated melange pattern creates a fascinating look that immediately catches the eye. But not just visually, the feel of this material is also impressive across the board. The wool is incredibly soft and comfortable, which guarantees a pleasant and cozy sitting or reclining experience.

The outstanding wear resistance of this material guarantees a long service life and maintains its aesthetics even with regular use and stress. This makes it a durable choice that can withstand the high demands of daily use.

Finally, the Capture wool cover meets the demanding requirements of the furniture industry, which further underlines its quality and performance. It is therefore a reliable option that meets the standards of the furniture industry.

## Capture-Specifications

Design no.	2472		
Composition	85% New Zealand wool / 15% polyamide		
Weight	g/lm 475 oz/lin.yd 15.32		
Width	cm 140 inches 55		
Abrasion	rubs martindale (EN ISO 12947-2) 200.000 rubs martindale (ASTM D4966) (heavy duty upholstery) 200.000 ASTM D4966 Martindale (heavy duty) pass  Abrasion test results exceeding ACT Performance Guidelines are not an indicator of product lifespan		
Pilling	scale 1-5, max. 5 - EN ISO 12945-2 ASTM D4970 Pilling	pass	4-5
Light fastness	scale 1-8, max. 8 - EN ISO 105-B02 AATCC 16 Light fastness	pass	5-7
Rubbing fastness	scale 1-5, max. 5 - EN ISO 105x12 (dry/wet)		4-5/4-5
Care instructions	dry cleaning P(S) 		
Flammability	BS EN 1021 1&2 Cigarette and Match BS 5852 Part 1 O,1 Cigarette & Match, The Furniture and Furnishing Regulations 1988 Class Uno UNI 9175 Class 1 I EMME CA TB 117-2013 ASTM E 84 Class 1 Will also pass other flammability standards. Flame retardant performance is dependent upon the foam used. Contains no flame retardant chemicals.		
Environment	OEKO-TEX® STANDARD 100 EU Ecolabel		

## Gabriel Select features

This impressive material boasts an elegant simplicity that is accompanied by an allround user-friendly design. With an extensive full spectrum color palette, it offers an almost endless variety of possibilities for design, making it fits perfectly with a wide variety of furnishing styles.

Thanks to its superior abrasion resistance, measured by an impressive 200,000 Martindale cycles, this material is extremely durable and resistant, even in heavy-duty environments. It is therefore an ideal choice for Highly frequented rooms such as public areas, offices or restaurants that require a durable solution.

The environmental friendliness of these materials is confirmed by the EU Ecolabel, which makes its production sustainable and environmentally friendly. It also fulfills the STANDARD 100 of OEKO-TEX®, which means that it has been tested for possible harmful substances is considered safe for human use.

## Select-Specifications

Design no.	2498		
Composition	85% New Zealand wool / 15% polyamide		
Weight	g/lm 510 oz/lin.yd 16.45		
Width	cm 140 inches 55		
Abrasion	rubs martindale (EN ISO 12947-2) 200.000 ASTM D4966 Martindale (heavy duty) rubs martindale (ASTM D4966) (heavy duty upholstery) 100.000  Abrasion test results exceeding ACT Performance Guidelines are not an indicator of product lifespan		
Pilling	scale 1-5, max. 5 - EN ISO 12945-2 ASTM D4970 Pilling	pass	4
Light fastness	scale 1-8, max. 8 - EN ISO 105-B02 AATCC 16 Light fastness	pass	5-8
Rubbing fastness	scale 1-5, max. 5 - EN ISO 105x12 (dry/wet) AATCC 8 or 116 Dry/wet crocking		4-5/4-5 pass
Care instructions	dry cleaning P(S) 		
Flammability	BS EN 1021-1 Cigarette BS EN 1021-2 Match BS 5852 Part 1 O,1 Cigarette & Match, The Furniture and Furnishing Regulations 1988 BS 5852 Crib 5 IMO MSC 307(88) Annex 1 part 8 MED Certificate IMO IMO MSC 307(88) Annex 1 part 8 UK MED Certificate IMO UK CA TB 117-2013 Will also pass other flammability standards. Flame retardant performance is dependent upon the foam used. Contains no flame retardant chemicals..		
Environment	OEKO-TEX® STANDARD 100 EU Ecolabel		



## Gabriel Cura features

The Cura fabric cover is characterized by a warm, casual aesthetic that is complemented by a lively melange effect and a soft, voluminous texture.

But this material is not only visually appealing - its high stretchability enables flexible use, making it perfect for office and lounge furniture. But what makes this material special is its sustainability. As much as 98% of the material is made from recycled post-consumer polyester, which makes a significant contribution to reducing waste. In addition, the entire material is 100% recyclable and therefore contributes to a closed-loop economy.

But this material also scores highly in terms of ecological standards. The EU Ecolabel shows that it meets strict environmental criteria and is therefore an environmentally friendly choice. It also fulfills meets the requirements of STANDARD 100 by OEKO-TEX®, which means that it has been tested for possible harmful substances and is considered safe for human use.

## Cura-Specifications

Design no.	2480/2544	
Composition	100% post-consumer recycled polyester	
Weight	g/lm 420 oz/lin.yd 55	
Width	cm 140 inches 55	
Abrasion	rubs Martindale (EN ISO 12947-2) 100.000 Double Rubs Wyzenbeek (ASTM D4157-07) (heavy duty upholstery) 100.000 ASTM D4157-07 Wyz-abrasion (heavy duty) 100k pass  Abrasion test results exceeding ACT Performance Guidelines are not an indicator of product lifespan	
Pilling	scale 1-5, max. 5 - EN ISO 12945-2 ASTM D3511 Pilling pass	4-5
Light fastness	scale 1-8, max. 8 - EN ISO 105-B02 AATCC 16 Light fastness pass	5-8
Rubbing fastness	scale 1-5, max. 5 - EN ISO 105x12 (dry/wet) AATCC 8 oder 116 Dry/wet crocking	4-5/4-5 pass
Care instructions	wash or dry cleaning P(W) Cura is made of polyester which is a material suited for environments with special requirements for cleaning.  40°C shrinkage max. 1%.  60°C shrinkage max. 2%.	
Flammability	BS EN 1021 1&2 Cigarette and Match CA TB 117-2013 ASTM E 84 Class 1 Will also pass other flammability standards. Flame retardant performance is dependent upon the foam used. Contains no flame retardant chemicals.	
Environment	OEKO-TEX® STANDARD 100 EU Ecolabel	

## Gabriel Comfort features

The high-quality fabric was specially developed for intensive use and has outstanding properties. With an impressive Martindale value of 150,000, it is extremely hard-wearing and resistant to abrasion.

Thanks to the use of carbon fibers, the fabric is permanently antistatic, which means that it hardly collects any dust and is therefore particularly easy to clean. Furthermore it is dirt-repellent and water and oil repellent, making it extremely resistant to soiling.

Another plus is its openness to diffusion, which means that the fabric enables excellent air and moisture exchange and thus counteracts the formation of mold.



Safety is a top priority with this fabric, as it is permanently fire-resistant - a property achieved by fire-retardant fibers. It therefore offers a high level of safety and protection.

For the environmentally conscious buyer, it is important to know that this fabric contains 37% recycled fibers, which contributes to the sustainable use of resources.

And to top it all off, the fabric manufacturer offers a generous 10-year guarantee against abrasion and pilling, which further reinforces confidence in the quality of this product.

The fabric also meets the requirements of the renowned STANDARD 100 by OEKO-TEX®, which means that it has been tested for harmful substances and is considered safe for human use.

## Comfort-Specifications

Design no.	8580	
Composition	51% polyester/37% post-consumer rec.pes./ 12% polyurethane incl. antistatic fibers and fire retardant fibers in the backside	
Weight	g/lm 385 oz/lin.yd 12.42	
Width	cm 140 inches 55	
Abrasion	rubs martindale (EN ISO 12947-2) 150.000  Abrasion test results exceeding ACT Performance Guidelines are not an indicator of product lifespan	
Pilling	scale 1-5, max. 5 - EN ISO 12945-2	5
Light fastness	scale 1-8, max. 8 - EN ISO 105-B02	5-7
Rubbing fastness	scale 1-5, max. 5 - EN ISO 105x12 (dry/wet)	4/4-5
Care instructions	wash or dry cleaning P(W)  most stains can be removed by brushing with a suede brush or using an eraser.  or use a solution of luke-warm water and a neutral detergent.  74°C shrinkage max. 2,5%.  60°C shrinkage max. 2%. 	
Flammability	BS EN 1021 1&2 Cigarette and Match BS EN 1021-1 Cigarette ÖNORM A3800-B2-B3825-Q1 UK NF P 92-503 M3 CA TB 117-2013 Will also pass other flammability standards. Flame retardant performance is dependent upon the foam used.	
Environment	OEKO-TEX® STANDARD 100	

## Gabriel Runner features

The Gabriel Runner fabric not only gives seating furniture an inviting and fascinating surface, but its colour palette also opens up a wide range of possible uses in the working environment and at home. Its design exudes comfort, elegance and robustness and can be perfectly combined with other Gabriel fabrics. 100% made from recyclable polyester, including 20% post-consumer recycled polyester, this fabric not only fulfils the demanding furniture facts requirements, but also proudly bears the EU Ecolabel and STANDARD 100 certification from OEKO-TEX®.

## Runner-Specifications

Design no.	8705
Composition	80% polyester / 20% post-consumer recycled polyester
Weight	g/lm 510 oz/lin.yd 16.45
Width	cm 160 inches 63
Abrasion	rubs martindale (EN ISO 12947-2)70,000 double rubs wyzenbeek (ASTM D4157) (heavy duty upholstery) 100,000 ASTM D4157-07 Wyz abrasion (heavy duty)pass Abrasion test results exceeding ACT Performance Guidelines are not an indicator of product lifespan
Pilling	scale 1-5, max. 5 - EN ISO 12945-2 5 ASTM D3511 Pilling pass
Light fastness	scale 1-8, max. 8 - EN ISO 105-B02 5-7 AATCC 16 Lichtechtheit pass
Rubbing fastness	scale 1-5, max. 5 - EN ISO 105x12 (dry/wet) 4-5/4-5 AATCC 8 oder 116 Nass-/Trocken-Crocking pass
Care instructions	wash or dry cleaning P(W). Runner is made of polyester which is a material suited for environments with special requirements for cleaning.  40°C shrinkage max. 5%.
Flammability	CA TB 117-2013 BS EN 1021-1 Cigarette BS EN 1021 1&2 Cigarette and Match Will also pass other flammability standards. Flame retardant performance is dependent upon the foam used. Contains no flame retardant chemicals.
Environment	OEKO-TEX® STANDARD 100 EU Ecolabel Cradle to Cradle Certified® Bronze

## Heller-Leder Atlantic features

The ideal upholstery for the office - Atlantic leather not only impresses with its high quality and beautiful surface embossing, but also offers optimum seating comfort. The soft leather is easy to care for, breathable and is characterised by its antistatic properties.

## Atlantic-Specifications

Test	Test Method	Measurement Unit	Guaranteed
Tear strength - Single edge tear	UNI EN ISO 3377-1	N	> = 20
Colour fastness to rubbing - Dry 500 Cycles	UNI EN ISO 11640:1998	Grey Scale	> = 4
Colour fastness to rubbing - Wet 250 Cycles	UNI EN ISO 11640:1998	Grey Scale	> = 4
Colour fastness to rubbing - Sweat 80 Cycles	UNI EN ISO 11640:1998 ISO 11641 pH8	Grey Scale	> = 4
Flexing endurance - Dry 50.000 Cycles	UNI EN ISO 5402		No damage
Finish Adhesion - Dry	UNI EN ISO 11644	N/cm	> = 2
Colour fastness to artificial light - Exposition energy 16.000kj/sqm	UNI EN ISO 105 B02 (MET.5)	Blue Scale	> = 5
Smolder resistance, cigarette and match flame	CAL TB-117 (2013, Sec. 1) BS 5852: 1979, source O-1 BS EN 1021-1-2:2006		Pass

## Elastron Uruguay features

The ideal cover for easy cleaning - the Uruguay faux leather impresses with a beautiful and even surface embossing and has a very good grip. The black faux leather cover makes this model a robust companion for many years.

## Uruguay-Specifications

Composition	Upper fabric: 100 % Polyurethane Underfabric: 80 % Polyester + 20 % Cotton
Weight	g/lm 600 (+/-5%)
Thickness	1,0 mm (+/-5%)
Tensile strength	EN ISO 1421 Warp: 774 N   21,0% Weft: 618 N   24,9%
Tear growth resistance	EN ISO 4674-1 Warp: 123,6 N Weft: 91,0 N
Seam Slippage resistance	EN ISO 13936-2 Warp: Kette: 3,0 mm Weft: 3,0 mm
Abrasion Test	EN ISO 5470-2 > 100.000
Colour Fastness	EN ISO 105 - B02
Reibechtheit	EN ISO 105 - X12   Dry 5   Wet 5
Permanent Creasing Behavior	DIN EN ISO 32100/DIN 53359 - 30.000 cycles PASS
Flammability	Fire Proof Norms BS 5852 Part 1 - Cigarette Test - PASS EN 1021-1 - Cigarette Test - PASS CA Tech. Bull. 117:2013 / NFPA 260 - Cigarette Test - PASS
Environment	OEKO-TEX® STANDARD 100 EU Ecolabel Cradle to Cradle Certified® Bronze

## Monteiro Mediflex features

The Monteiro cover impresses with its clear, functional appearance and is consistently designed for professional use. The understated look is high-quality and fits easily into different room and usage concepts – from functional working environments to medical and care facilities.

The material is designed for heavy use and offers excellent resistance in daily continuous use. Even with intensive use, the surface and structure remain stable, which supports a long service life and reduces maintenance requirements.

A key advantage is that it is very easy to care for and clean. The surface is easy to clean and meets the requirements of hygienically sensitive areas. At the same time, the material properties ensure pleasant seating comfort without compromising robustness.

## Mediflex specifications

Weight per unit area	640 g/m <sup>2</sup> ± 5 %
Material thickness	1,00 – 1,20 mm
Composition	88 % PVC / 12 % PA
Product range	1,37 – 1,40 m
Abrasion resistance	400,000 Martindale cycles (ISO 5470-2)
Cold resistance	Cold crack resistant
Colour fastness / durability	Friction (ISO 105-X12) / Ethyl alcohol 70% Bleach (4.5% chlorine) / Acidic and alkaline sweat solutions (ISO 105-EO4) / Saliva (DIN 53160-1) Artificial blood / Artificial urine / Massage oil / Hand cream
Light fastness	Artificial weathering (ISO 105-B04) Artificial light (ISO 105-B02)
Fire behaviour	FMVSS 302 / EN 1021-1 + 2 / NFPA 260 – Class 1 California Technical Bulletin 117 – Section 11MO 2020 FTP Code Part 8
Antibacterial / antifungal properties	Sanitized® (ISO 20743, ISO 846 A)
Antiviral properties	Log reduction: 75.52% (ISO 18184)
Biocompatibility	ISO 10993-10 – Tests for irritation and delayed hypersensitivity / ISO 10993-5 – In vitro cytotoxicity
Care	Easy to clean with mild detergent and a damp cloth  Free from harmful substances / phthalate-free  Manufactured in accordance with REACH (EC No. 1907/2006)  Suitable for toys and children's products (Directive 2005/84/EC)

## Notes

Subject to technical change and model modifications. Colours may vary slightly from batch to batch. Freight costs on request. The valid general terms and conditions of Aerus GmbH apply. The Price List 04/2026 renders all previous price lists invalid. No liability is taken for errors, printing errors and changes in prices or product specifications. Please note, that not all products are available in all countries. If you have any questions, please contact the Aerus team.