

Price List

Aeris Swopper

The Aeris Swopper prices are determined by the type of footring (glides or castors) and the different seat covers.

Seat cover	Aeris Swopper with glides Recommended retail price in EUR excl. VAT	Aeris Swopper with castors Recommended retail price in EUR excl. VAT
Artificial leather (Uruguay, Elastron)	€ 553.78	€ 587.39
Recycled Post-Consumer Polyester (Cura, Gabriel)	€ 570.59	€ 604.20
Wool blend (Capture, Gabriel)	€ 578.99	€ 612.61
Wool blend (Select, Gabriel)	€ 578.99	€ 612.61
Artificial leather (Mediflex, Monteiro)	€ 578.99	€ 612.61
Microfibre (Comfort, Gabriel)	€ 587.39	€ 621.01
Mesh fabric Runner (Gabriel)*	€ 587.39	€ 621.01
Leather (Atlantic, Heller-Leder)	€ 671.43	€ 705.04

* Swopper Air: Seat (multi-layer structure)

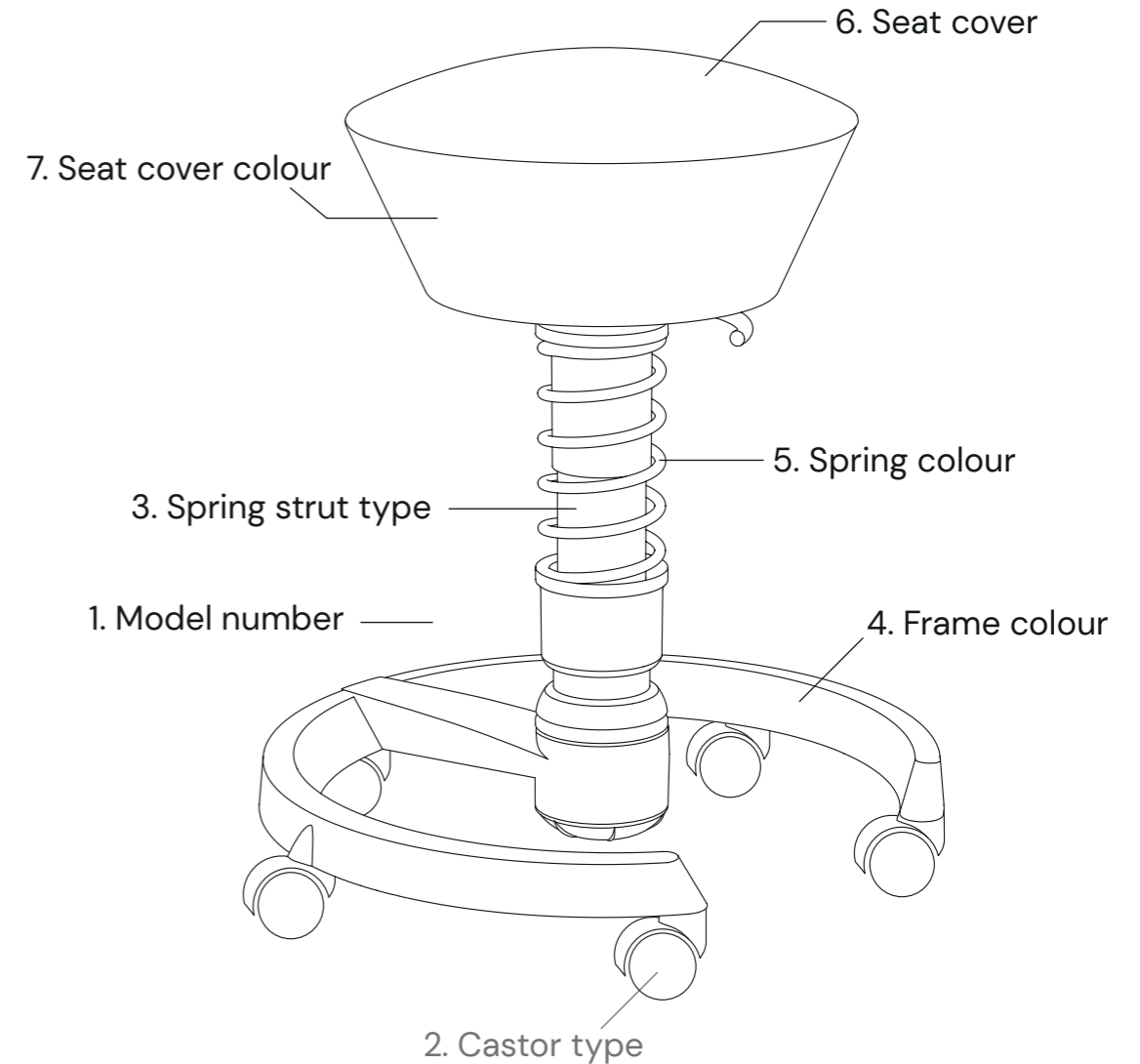

Components of the Aeris Swopper article number easily explained.

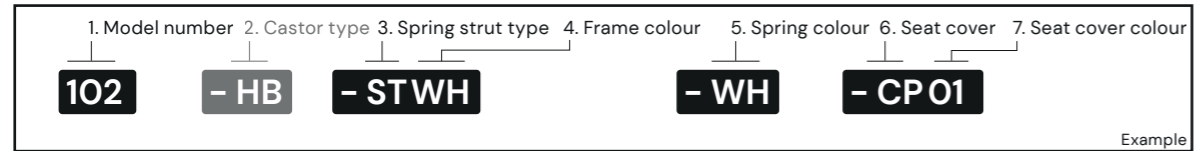

1. Model number	Article code
Glides	101
Castors	102

2. Castor type (only for model 102 with castors)	Article code
Hard floor castors (tiles, parquet, laminate or similar)	- HB
Soft floor castors (carpet, PVC, felt or similar)	- WB

3. Spring strut type	Article code
Standard: Body weight: 50 - 120 kg Height adjustment range under load: 45 - 59 cm Height adjustment range without load: 52 - 66 cm	- ST
Low: Body weight: 50 - 120kg Height adjustment range under load: 42 - 56 cm Height adjustment range without load: 50 - 64 cm	- LO
High:* Body weight: 50 - 120kg Height adjustment range under load: 49 - 69 cm Height adjustment range without load: 56 - 76 cm	- HI
Light: Body weight: 35 - 50kg Height adjustment range under load: 42 - 56 cm Height adjustment range without load: 47 - 61 cm	- LI

* Available only for Aeris Swopper with glides.

4. Frame colour	Article code
white	WH
black	BK

5. Spring colour*	Article code
white	- WH
black	- BK

* Spring colour same as the frame colour (white, black).

6. Seat cover	Article code
Artificial leather (Uruguay, Elastron)	- UR
Recycled Post-Consumer Polyester (Cura, Gabriel)	- CU
Wool blend (Capture, Gabriel)	- CP
Wool blend (Select, Gabriel)	- SE
Artificial leather (Mediflex, Monteiro)	- ME
Microfibre (Comfort, Gabriel)	- CM
Mesh fabric (Runner, Gabriel)	- RN
Leather (Atlantic, Heller-Leder)	- LA

7. Seat cover colour

Please first select the seat cover colour for the Aeris Swopper. The relevant article code (Aeris colour code) can be found on the following pages. Simply put it behind the article code of the seat cover (without hyphen).

Aeris Swopper Fabric sample overview

Capture / Gabriel

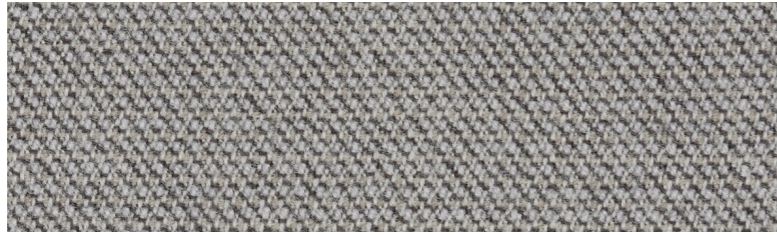

Select / Gabriel



CP01, black
melange
5501

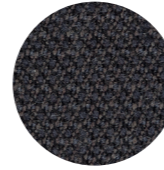

CP05, green
melange
5301

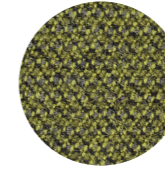

CP22, stone grey
melange
4102

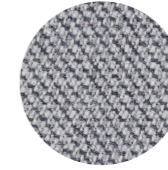

CP24, slate grey
melange
4601

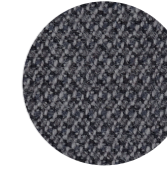

CP26, pigeon blue
melange
4902



CP28, petrol blue
melange
5001

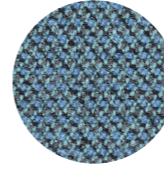

CP29, dark red
melange
5402

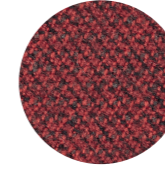

CP30, orange-red
melange
4301

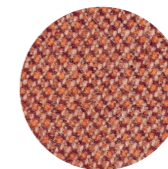

CP31, pink-red
melange
4802

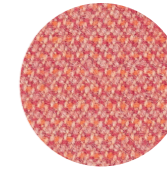

CP35, green-beige
melange
5101

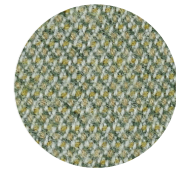

SE01, black
60999



SE02, grey
60130



SE03, red
64089

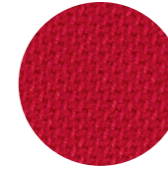

SE04, blue
66071

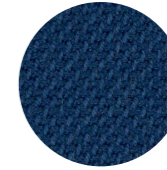

SE05, green
67095



SE07, slate grey
60134

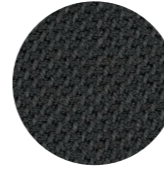

SE10, pastel blue
67098

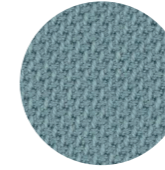

SE11, azure blue
66192

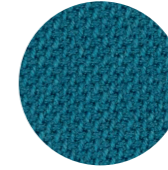

SE15, pale pink
65117

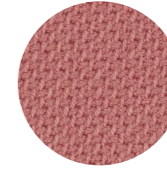

SE19, turquoise
67100

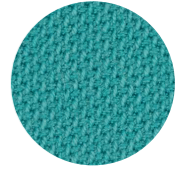

Aeris Swopper Fabric sample overview

Cura / Gabriel

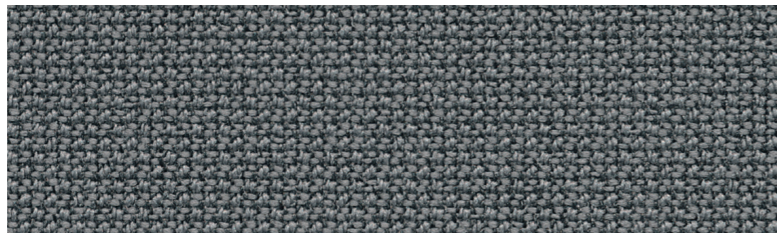

Comfort / Gabriel



Runner / Gabriel



CU01, black

60111

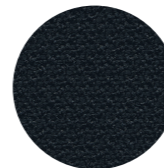

CU02, grey melange

60110

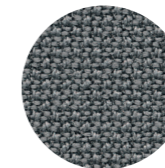

CU04, blue melange

66167

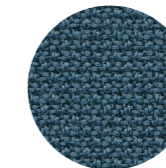

CU06, yellow melange

62084

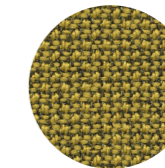

CU09, light violet melange

64194

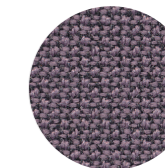

CU12, petrol blue melange

67084

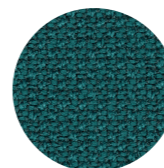

CU13, pale green melange

68186

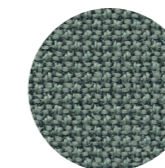

CU14, fern green melange

68181

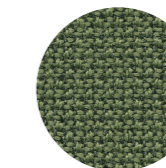

CU16, beige melange

61168

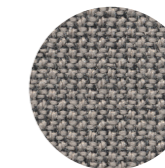

CU17, light grey melange

60112

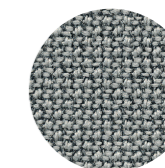

CM01, black

0050

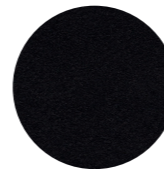

CM02, grey

1012

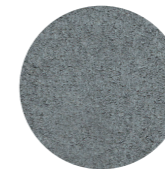

CM03, red

1414

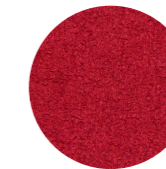

CM04, blue

66004

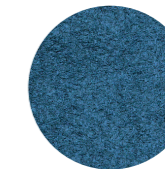

CM05, green

8397

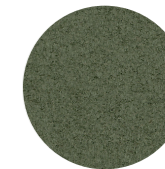

RN01, black

60999

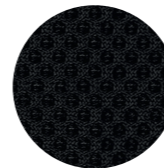

RN02, grey

60011

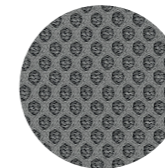

RN03, red

64119

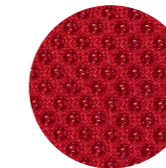

RN04, blue

66123

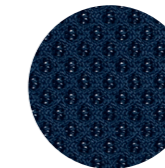

RN05, green

68110

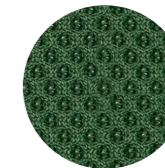

Aeris Swopper Fabric sample overview

Uruguay / Elastron

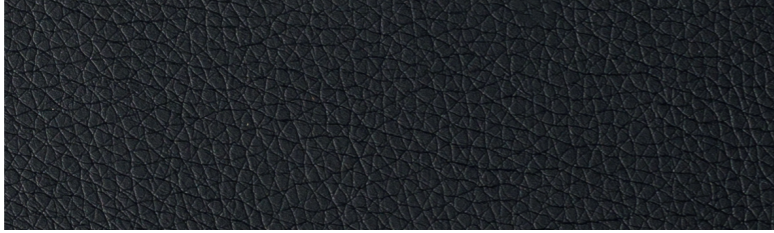

UR01, black
13-901



Mediflex / Monteiro



ME01, black
67796

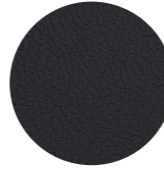

Atlantic / Heller-Leder

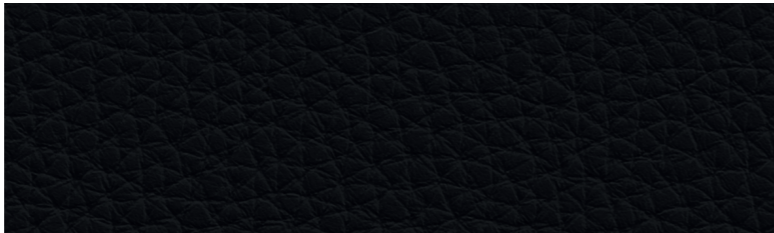

LA01, black
35002 999



Gabriel Capture features

The use of lightly felted, multicolored wool in this material gives it a unique and appealing texture. The sophisticated melange pattern creates a fascinating look that immediately catches the eye. But not just visually, the feel of this material is also impressive across the board. The wool is incredibly soft and comfortable, which guarantees a pleasant and cozy sitting or reclining experience.

The outstanding wear resistance of this material guarantees a long service life and maintains its aesthetics even with regular use and stress. This makes it a durable choice that can withstand the high demands of daily use.

Finally, the Capture wool cover meets the demanding requirements of the furniture industry, which further underlines its quality and performance. It is therefore a reliable option that meets the standards of the furniture industry.

Capture-Specifications

Design no.	2472	
Composition	85% New Zealand wool / 15% polyamide	
Weight	g/lm 475 oz/lin.yd 15.32	
Width	cm 140 inches 55	
Abrasion	rubs martindale (EN ISO 12947-2) 200.000 rubs martindale (ASTM D4966) (heavy duty upholstery) 200.000 ASTM D4966 Martindale (heavy duty) pass Abrasion test results exceeding ACT Performance Guidelines are not an indicator of product lifespan	
Pilling	scale 1-5, max. 5 - EN ISO 12945-2 ASTM D4970 Pilling pass	4-5
Light fastness	scale 1-8, max. 8 - EN ISO 105-B02 AATCC 16 Light fastness pass	5-7
Rubbing fastness	scale 1-5, max. 5 - EN ISO 105x12 (dry/wet)	4-5/4-5
Care instructions	dry cleaning P(S) 	
Flammability	BS EN 1021 1&2 Cigarette and Match BS 5852 Part 1 O,1 Cigarette & Match, The Furniture and Furnishing Regulations 1988 Class Uno UNI 9175 Class 1 I EMME CA TB 117-2013 ASTM E 84 Class 1 Will also pass other flammability standards. Flame retardant performance is dependent upon the foam used. Contains no flame retardant chemicals.	
Environment	OEKO-TEX® STANDARD 100 EU Ecolabel	

Gabriel Select features

This impressive material boasts an elegant simplicity that is accompanied by an allround user-friendly design. With an extensive full spectrum color palette, it offers an almost endless variety of possibilities for design, making it fits perfectly with a wide variety of furnishing styles.

Thanks to its superior abrasion resistance, measured by an impressive 200,000 Martindale cycles, this material is extremely durable and resistant, even in heavy-duty environments. It is therefore an ideal choice for Highly frequented rooms such as public areas, offices or restaurants that require a durable solution.

The environmental friendliness of these materials is confirmed by the EU Ecolabel, which makes its production sustainable and environmentally friendly. It also fulfills the STANDARD 100 of OEKO-TEX®, which means that it has been tested for possible harmful substances is considered safe for human use.

Select-Specifications

Design no.	2498	
Composition	85% New Zealand wool / 15% polyamide	
Weight	g/lm 510 oz/lin.yd 16.45	
Width	cm 140 inches 55	
Abrasion	rubs martindale (EN ISO 12947-2) 200.000 ASTM D4966 Martindale (heavy duty) rubs martindale (ASTM D4966) (heavy duty upholstery) 100.000 Abrasion test results exceeding ACT Performance Guidelines are not an indicator of product lifespan	
Pilling	scale 1-5, max. 5 - EN ISO 12945-2 ASTM D4970 Pilling pass	4
Light fastness	scale 1-8, max. 8 - EN ISO 105-B02 AATCC 16 Light fastness pass	5-8
Rubbing fastness	scale 1-5, max. 5 - EN ISO 105x12 (dry/wet) AATCC 8 or 116 Dry/wet crocking	4-5/4-5 pass
Care instructions	dry cleaning P(S) 	
Flammability	BS EN 1021-1 Cigarette BS EN 1021-2 Match BS 5852 Part 1 O,1 Cigarette & Match, The Furniture and Furnishing Regulations 1988 BS 5852 Crib 5 IMO MSC 307(88) Annex 1 part 8 MED Certificate IMO IMO MSC 307(88) Annex 1 part 8 UK MED Certificate IMO UK CA TB 117-2013 Will also pass other flammability standards. Flame retardant performance is dependent upon the foam used. Contains no flame retardant chemicals..	
Environment	OEKO-TEX® STANDARD 100 EU Ecolabel	



Gabriel Cura features

The Cura fabric cover is characterized by a warm, casual aesthetic that is complemented by a lively melange effect and a soft, voluminous texture.

But this material is not only visually appealing - its high stretchability enables flexible use, making it perfect for office and lounge furniture. But what makes this material special is its sustainability. As much as 98% of the material is made from recycled post-consumer polyester, which makes a significant contribution to reducing waste. In addition, the entire material is 100% recyclable and therefore contributes to a closed-loop economy.

But this material also scores highly in terms of ecological standards. The EU Ecolabel shows that it meets strict environmental criteria and is therefore an environmentally friendly choice. It also fulfills meets the requirements of STANDARD 100 by OEKO-TEX®, which means that it has been tested for possible harmful substances and is considered safe for human use.

Cura-Specifications

Design no.	2480/2544	
Composition	100% post-consumer recycled polyester	
Weight	g/lm 420 oz/lin.yd 55	
Width	cm 140 inches 55	
Abrasion	rubs Martindale (EN ISO 12947-2) 100.000 Double Rubs Wyzenbeek (ASTM D4157-07) (heavy duty upholstery) 100.000 ASTM D4157-07 Wyz-abrasion (heavy duty) 100k pass Abrasion test results exceeding ACT Performance Guidelines are not an indicator of product lifespan	
Pilling	scale 1-5, max. 5 - EN ISO 12945-2 ASTM D3511 Pilling pass	4-5
Light fastness	scale 1-8, max. 8 - EN ISO 105-B02 AATCC 16 Light fastness pass	5-8
Rubbing fastness	scale 1-5, max. 5 - EN ISO 105x12 (dry/wet) AATCC 8 oder 116 Dry/wet crocking	4-5/4-5 pass
Care instructions	wash or dry cleaning P(W) Cura is made of polyester which is a material suited for environments with special requirements for cleaning.  40°C shrinkage max. 1%.  60°C shrinkage max. 2%.	
Flammability	BS EN 1021 1&2 Cigarette and Match CA TB 117-2013 ASTM E 84 Class 1 Will also pass other flammability standards. Flame retardant performance is dependent upon the foam used. Contains no flame retardant chemicals.	
Environment	OEKO-TEX® STANDARD 100 EU Ecolabel	

Gabriel Comfort features

The high-quality fabric was specially developed for intensive use and has outstanding properties. With an impressive Martindale value of 150,000, it is extremely hard-wearing and resistant to abrasion.

Thanks to the use of carbon fibers, the fabric is permanently antistatic, which means that it hardly collects any dust and is therefore particularly easy to clean. Furthermore it is dirt-repellent and water and oil repellent, making it extremely resistant to soiling.

Another plus is its openness to diffusion, which means that the fabric enables excellent air and moisture exchange and thus counteracts the formation of mold.



Safety is a top priority with this fabric, as it is permanently fire-resistant - a property achieved by fire-retardant fibers. It therefore offers a high level of safety and protection.

For the environmentally conscious buyer, it is important to know that this fabric contains 37% recycled fibers, which contributes to the sustainable use of resources.

And to top it all off, the fabric manufacturer offers a generous 10-year guarantee against abrasion and pilling, which further reinforces confidence in the quality of this product.

The fabric also meets the requirements of the renowned STANDARD 100 by OEKO-TEX®, which means that it has been tested for harmful substances and is considered safe for human use.

Comfort-Specifications

Design no.	8580	
Composition	51% polyester/37% post-consumer rec.pes./ 12% polyurethane incl. antistatic fibers and fire retardant fibers in the backside	
Weight	g/lm 385 oz/lin.yd 12.42	
Width	cm 140 inches 55	
Abrasion	rubs martindale (EN ISO 12947-2) 150.000 Abrasion test results exceeding ACT Performance Guidelines are not an indicator of product lifespan	
Pilling	scale 1-5, max. 5 - EN ISO 12945-2	5
Light fastness	scale 1-8, max. 8 - EN ISO 105-B02	5-7
Rubbing fastness	scale 1-5, max. 5 - EN ISO 105x12 (dry/wet)	4/4-5
Care instructions	wash or dry cleaning P(W) most stains can be removed by brushing with a suede brush or using an eraser. or use a solution of luke-warm water and a neutral detergent. 74°C shrinkage max. 2,5%.  60°C shrinkage max. 2%. 	
Flammability	BS EN 1021 1&2 Cigarette and Match BS EN 1021-1 Cigarette ÖNORM A3800-B2-B3825-Q1 UK NF P 92-503 M3 CA TB 117-2013 Will also pass other flammability standards. Flame retardant performance is dependent upon the foam used.	
Environment	OEKO-TEX® STANDARD 100	

Gabriel Runner features

The Gabriel Runner fabric not only gives seating furniture an inviting and fascinating surface, but its colour palette also opens up a wide range of possible uses in the working environment and at home. Its design exudes comfort, elegance and robustness and can be perfectly combined with other Gabriel fabrics. 100% made from recyclable polyester, including 20% post-consumer recycled polyester, this fabric not only fulfils the demanding furniture facts requirements, but also proudly bears the EU Ecolabel and STANDARD 100 certification from OEKO-TEX®.

Runner-Specifications

Design no.	8705
Composition	80% polyester / 20% post-consumer recycled polyester
Weight	g/lm 510 oz/lin.yd 16.45
Width	cm 160 inches 63
Abrasion	rubs martindale (EN ISO 12947-2)70,000 double rubs wyzenbeek (ASTM D4157) (heavy duty upholstery) 100,000 ASTM D4157-07 Wyz abrasion (heavy duty)pass Abrasion test results exceeding ACT Performance Guidelines are not an indicator of product lifespan
Pilling	scale 1-5, max. 5 - EN ISO 12945-2 5 ASTM D3511 Pilling pass
Light fastness	scale 1-8, max. 8 - EN ISO 105-B02 5-7 AATCC 16 Lichtechtheit pass
Rubbing fastness	scale 1-5, max. 5 - EN ISO 105x12 (dry/wet) 4-5/4-5 AATCC 8 oder 116 Nass-/Trocken-Crocking pass
Care instructions	wash or dry cleaning P(W). Runner is made of polyester which is a material suited for environments with special requirements for cleaning.  40°C shrinkage max. 5%.
Flammability	CA TB 117-2013 BS EN 1021-1 Cigarette BS EN 1021 1&2 Cigarette and Match Will also pass other flammability standards. Flame retardant performance is dependent upon the foam used. Contains no flame retardant chemicals.
Environment	OEKO-TEX® STANDARD 100 EU Ecolabel Cradle to Cradle Certified® Bronze

Heller-Leder Atlantic features

The ideal upholstery for the office - Atlantic leather not only impresses with its high quality and beautiful surface embossing, but also offers optimum seating comfort. The soft leather is easy to care for, breathable and is characterised by its antistatic properties.

Atlantic-Specifications

Test	Test Method	Measurement Unit	Guaranteed
Tear strength - Single edge tear	UNI EN ISO 3377-1	N	> = 20
Colour fastness to rubbing - Dry 500 Cycles	UNI EN ISO 11640:1998	Grey Scale	> = 4
Colour fastness to rubbing - Wet 250 Cycles	UNI EN ISO 11640:1998	Grey Scale	> = 4
Colour fastness to rubbing - Sweat 80 Cycles	UNI EN ISO 11640:1998 ISO 11641 pH8	Grey Scale	> = 4
Flexing endurance - Dry 50.000 Cycles	UNI EN ISO 5402		No damage
Finish Adhesion - Dry	UNI EN ISO 11644	N/cm	> = 2
Colour fastness to artificial light - Exposition energy 16.000kj/sqm	UNI EN ISO 105 B02 (MET.5)	Blue Scale	> = 5
Smolder resistance, cigarette and match flame	CAL TB-117 (2013, Sec. 1) BS 5852: 1979, source O-1 BS EN 1021-1-2:2006		Pass

Elastron Uruguay features

The ideal cover for easy cleaning - the Uruguay faux leather impresses with a beautiful and even surface embossing and has a very good grip. The black faux leather cover makes this model a robust companion for many years.

Uruguay-Specifications

Composition	Upper fabric: 100 % Polyurethane Underfabric: 80 % Polyester + 20 % Cotton
Weight	g/lm 600 (+/-5%)
Thickness	1,0 mm (+/-5%)
Tensile strength	EN ISO 1421 Warp: 774 N 21,0% Weft: 618 N 24,9%
Tear growth resistance	EN ISO 4674-1 Warp: 123,6 N Weft: 91,0 N
Seam Slippage resistance	EN ISO 13936-2 Warp: Kette: 3,0 mm Weft: 3,0 mm
Abrasion Test	EN ISO 5470-2 > 100.000
Colour Fastness	EN ISO 105 - B02
Reibechtheit	EN ISO 105 - X12 Dry 5 Wet 5
Permanent Creasing Behavior	DIN EN ISO 32100/DIN 53359 - 30.000 cycles PASS
Flammability	Fire Proof Norms BS 5852 Part 1 - Cigarette Test - PASS EN 1021-1 - Cigarette Test - PASS CA Tech. Bull. 117:2013 / NFPA 260 - Cigarette Test - PASS
Environment	OEKO-TEX® STANDARD 100 EU Ecolabel Cradle to Cradle Certified® Bronze

Monteiro Mediflex features

The Monteiro cover impresses with its clear, functional appearance and is consistently designed for professional use. The understated look is high-quality and fits easily into different room and usage concepts – from functional working environments to medical and care facilities.

The material is designed for heavy use and offers excellent resistance in daily continuous use. Even with intensive use, the surface and structure remain stable, which supports a long service life and reduces maintenance requirements.

A key advantage is that it is very easy to care for and clean. The surface is easy to clean and meets the requirements of hygienically sensitive areas. At the same time, the material properties ensure pleasant seating comfort without compromising robustness.

Mediflex specifications

Weight per unit area	640 g/m ² ± 5 %
Material thickness	1,00 – 1,20 mm
Composition	88 % PVC / 12 % PA
Product range	1,37 – 1,40 m
Abrasion resistance	400,000 Martindale cycles (ISO 5470-2)
Cold resistance	Cold crack resistant
Colour fastness / durability	Friction (ISO 105-X12) / Ethyl alcohol 70% Bleach (4.5% chlorine) / Acidic and alkaline sweat solutions (ISO 105-EO4) / Saliva (DIN 53160-1) Artificial blood / Artificial urine / Massage oil / Hand cream
Light fastness	Artificial weathering (ISO 105-B04) Artificial light (ISO 105-B02)
Fire behaviour	FMVSS 302 / EN 1021-1 + 2 / NFPA 260 – Class 1 California Technical Bulletin 117 – Section 11MO 2020 FTP Code Part 8
Antibacterial / antifungal properties	Sanitized® (ISO 20743, ISO 846 A)
Antiviral properties	Log reduction: 75.52% (ISO 18184)
Biocompatibility	ISO 10993-10 – Tests for irritation and delayed hypersensitivity / ISO 10993-5 – In vitro cytotoxicity
Care	Easy to clean with mild detergent and a damp cloth Free from harmful substances / phthalate-free Manufactured in accordance with REACH (EC No. 1907/2006) Suitable for toys and children's products (Directive 2005/84/EC)

Notes

Subject to technical change and model modifications. Colours may vary slightly from batch to batch. Freight costs on request. The valid general terms and conditions of Aeris GmbH apply. The Price List 04/2026 renders all previous price lists invalid. No liability is taken for errors, printing errors and changes in prices or product specifications. Please note, that not all products are available in all countries. If you have any questions, please contact the Aeris team.

Price List

Aeris Swopper with backrest

The prices for the Aeris Swopper with backrest are determined by the different seat and backrest covers.

Seat and backrest cover	Aeris Swopper with backrest Recommended retail price in EUR excl. VAT
Recycled post-consumer polyester (Cura, Gabriel)	€ 780.67
Wool blend (Capture, Gabriel)	€ 789.08
Wool blend (Select, Gabriel)	€ 789.08
Microfibre (Comfort, Gabriel)	€ 814.29
Mesh fabric (Runner, Gabriel)*	€ 814.29

* Swopper Air: Seat (multi-layer structure)

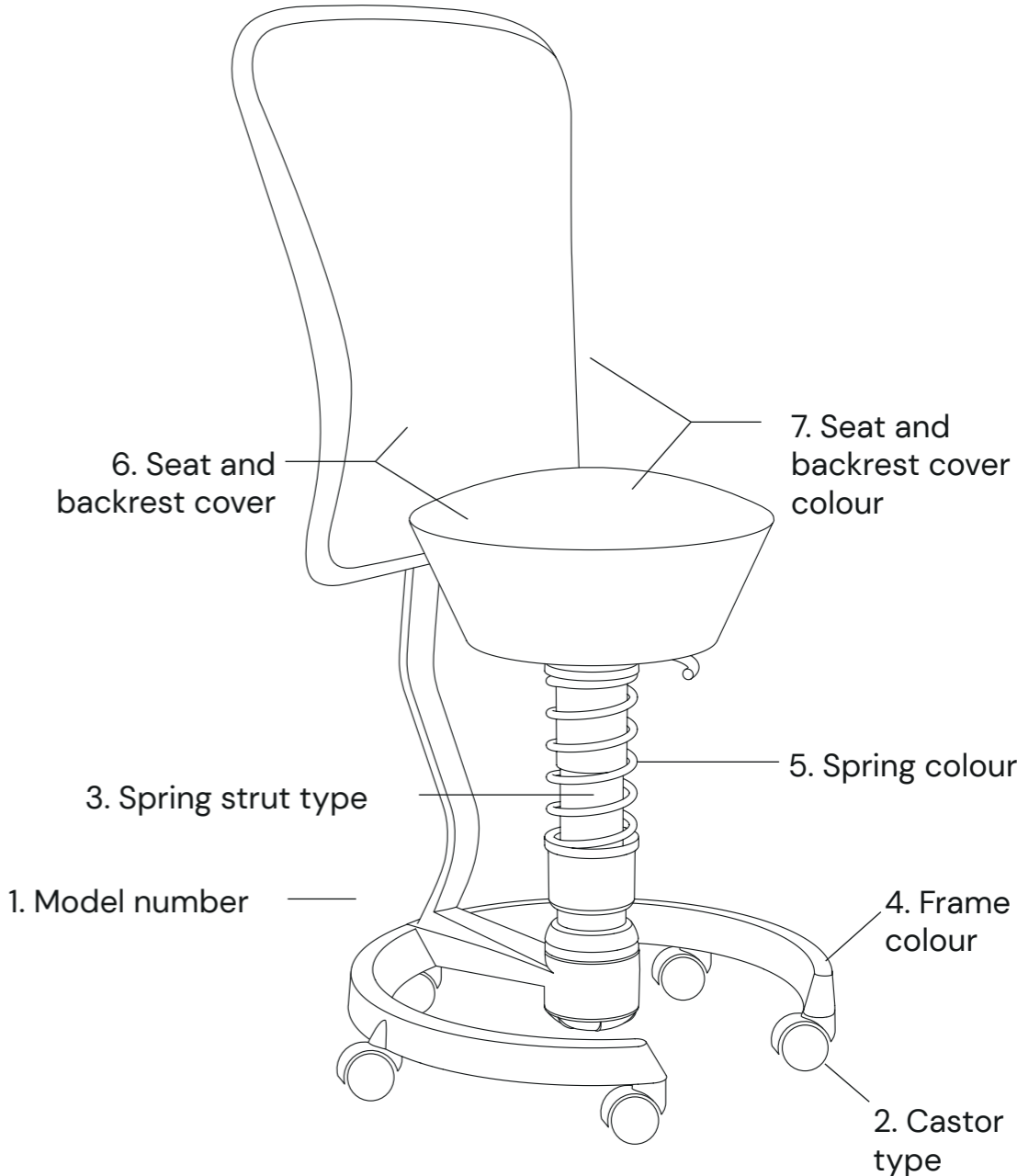

Components of the article number of the Aeris Swopper with backrest easily explained.

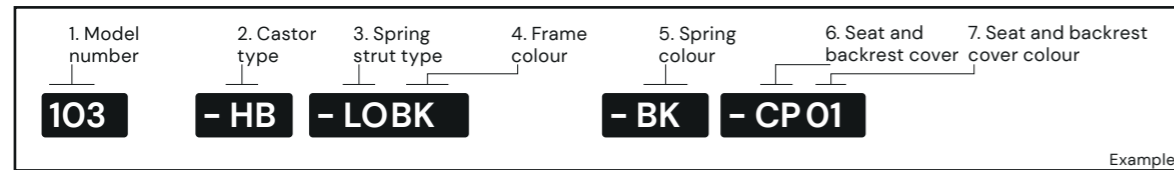

1. Model number

	Article code
Swopper with backrest	103

5. Spring colour

	Article code
black	- BK
white	- WH

2. Castor type

	Article code
Hard floor castors (tiles, parquet, laminate or similar)	- HB
Soft floor castors (carpet, PVC, felt or similar)	- WB

6. Seat and backrest cover

	Article code
Wool blend (Capture, Gabriel)	- CP
Wool blend (Select, Gabriel)	- SE
Recycled post-consumer polyester (Cura, Gabriel)	- CU
Microfibre (Comfort, Gabriel)	- CM
Mesh fabric (Runner, Gabriel)	- RN

3. Spring strut type

	Article code
Standard: Body weight: 50 - 120 kg Height adjustment range under load: 45 - 59 cm Height adjustment range without load: 52 - 66 cm	- ST
Low*: Body weight: 50 - 120 kg Height adjustment range under load: 42 - 56 cm Height adjustment range without load: 50 - 64 cm	- LO
Light: Body weight: 35 - 50 kg Height adjustment range under load: 42 - 56 cm Height adjustment range without load: 47 - 61 cm	- LI

7. Seat and backrest cover colour

Please first choose the seat and backrest cover colour for the Aeris Swopper. The relevant article code (Aeris colour code) can be found on the following pages. Simply put it behind the article code of the seat and backrest cover (without hyphen).

4. Frame colour

	Article code
black	BK
white	WH

Aeris Swopper with backrest Fabric sample overview

Capture / Gabriel

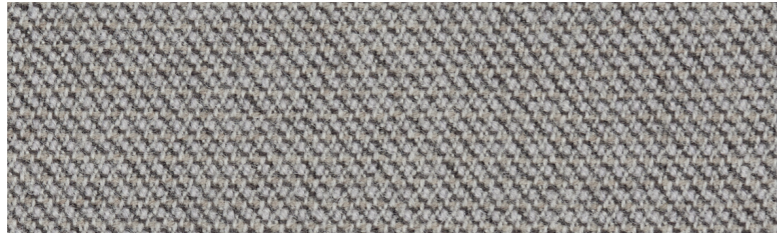

Select / Gabriel



Comfort / Gabriel



Runner / Gabriel



CP01, black
melange
5501

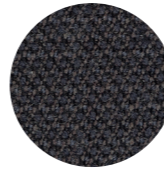

CP05, green
melange
5301

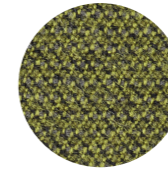

CP22, stone grey
melange
4102

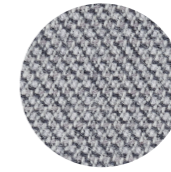

outlet fabric

SE01, black
60999



SE02, grey
60130



SE03, red
64089

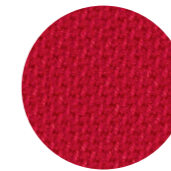

SE04, blue
66071

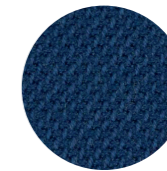

SE05, green
67095

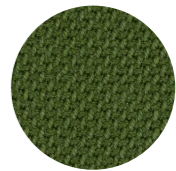

outlet fabric

outlet fabric

outlet fabric

CM01, black
0050

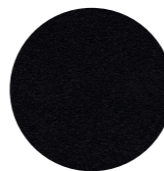

CM02, grey
1012

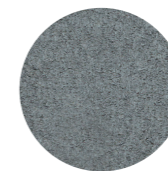

CM03, red
1414

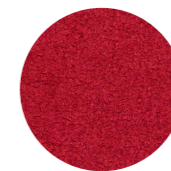

CM04, blue
66004

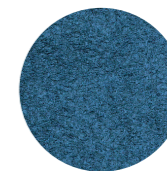

CM05, green
8397



RN01, black
60999

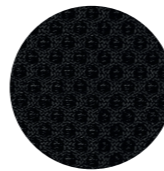

RN02, grey
60011

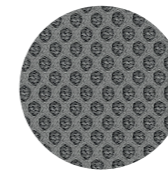

RN03, red
64119

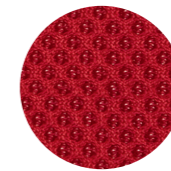

RN04, blue
66123

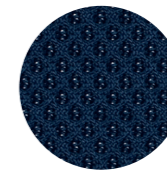

RN05, green
68110

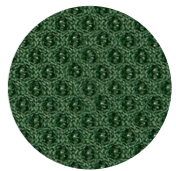

outlet fabric

outlet fabric

outlet fabric

Aeris Swopper with backrest Fabric sample overview

Cura / Gabriel

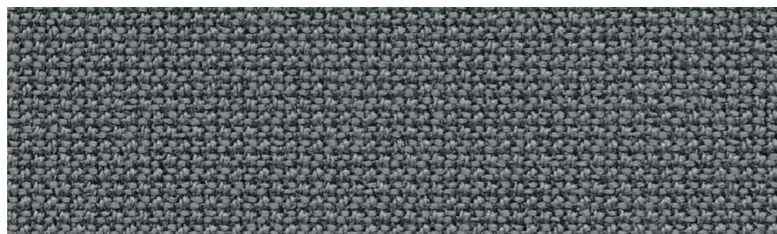

CU01, black

60111

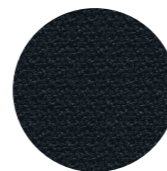

CU02, grey
melange

60110

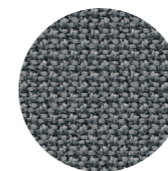

Gabriel Capture features

The use of lightly felted, multicolored wool in this material gives it a unique and appealing texture. The sophisticated melange pattern creates a fascinating look that immediately catches the eye. But not just visually, the feel of this material is also impressive across the board. The wool is incredibly soft and comfortable, which guarantees a pleasant and cozy sitting or reclining experience.

The outstanding wear resistance of this material guarantees a long service life and maintains its aesthetics even with regular use and stress. This makes it a durable choice that can withstand the high demands of daily use.

Finally, the Capture wool cover meets the demanding requirements of the furniture industry, which further underlines its quality and performance. It is therefore a reliable option that meets the standards of the furniture industry.

Capture-Specifications

Design no.	2472		
Composition	85% New Zealand wool / 15% polyamide		
Weight	g/lm 475 oz/lin.yd 15.32		
Width	cm 140 inches 55		
Abrasion	rubs martindale (EN ISO 12947-2) 200.000 rubs martindale (ASTM D4966) (heavy duty upholstery) 200.000 ASTM D4966 Martindale (heavy duty) pass Abrasion test results exceeding ACT Performance Guidelines are not an indicator of product lifespan		
Pilling	scale 1-5, max. 5 - EN ISO 12945-2 ASTM D4970 Pilling	pass	4-5
Light fastness	scale 1-8, max. 8 - EN ISO 105-B02 AATCC 16 Light fastness	pass	5-7
Rubbing fastness	scale 1-5, max. 5 - EN ISO 105x12 (dry/wet)		4-5/4-5
Care instructions	dry cleaning P(S) 		
Flammability	BS EN 1021 1&2 Cigarette and Match BS 5852 Part 1 O,1 Cigarette & Match, The Furniture and Furnishing Regulations 1988 Class Uno UNI 9175 Class 1 I EMME CA TB 117-2013 ASTM E 84 Class 1 Will also pass other flammability standards. Flame retardant performance is dependent upon the foam used. Contains no flame retardant chemicals.		
Environment	OEKO-TEX® STANDARD 100 EU Ecolabel		

Gabriel Select features

This impressive material boasts an elegant simplicity that is accompanied by an allround user-friendly design. With an extensive full spectrum color palette, it offers an almost endless variety of possibilities for design, making it fits perfectly with a wide variety of furnishing styles.

Thanks to its superior abrasion resistance, measured by an impressive 200,000 Martindale cycles, this material is extremely durable and resistant, even in heavy-duty environments. It is therefore an ideal choice for Highly frequented rooms such as public areas, offices or restaurants that require a durable solution.

The environmental friendliness of these materials is confirmed by the EU Ecolabel, which makes its production sustainable and environmentally friendly. It also fulfills the STANDARD 100 of OEKO-TEX®, which means that it has been tested for possible harmful substances is considered safe for human use.

Select-Specifications

Design no.	2498		
Composition	85% New Zealand wool / 15% polyamide		
Weight	g/lm 510 oz/lin.yd 16.45		
Width	cm 140 inches 55		
Abrasion	rubs martindale (EN ISO 12947-2) 200.000 ASTM D4966 Martindale (heavy duty) rubs martindale (ASTM D4966) (heavy duty upholstery) 100.000 Abrasion test results exceeding ACT Performance Guidelines are not an indicator of product lifespan		
Pilling	scale 1-5, max. 5 - EN ISO 12945-2 ASTM D4970 Pilling	pass	4
Light fastness	scale 1-8, max. 8 - EN ISO 105-B02 AATCC 16 Light fastness	pass	5-8
Rubbing fastness	scale 1-5, max. 5 - EN ISO 105x12 (dry/wet) AATCC 8 or 116 Dry/wet crocking		4-5/4-5 pass
Care instructions	dry cleaning P(S) 		
Flammability	BS EN 1021-1 Cigarette BS EN 1021-2 Match BS 5852 Part 1 O,1 Cigarette & Match, The Furniture and Furnishing Regulations 1988 BS 5852 Crib 5 IMO MSC 307(88) Annex 1 part 8 MED Certificate IMO IMO MSC 307(88) Annex 1 part 8 UK MED Certificate IMO UK CA TB 117-2013 Will also pass other flammability standards. Flame retardant performance is dependent upon the foam used. Contains no flame retardant chemicals..		
Environment	OEKO-TEX® STANDARD 100 EU Ecolabel		

Gabriel Comfort features

The high-quality fabric was specially developed for intensive use and has outstanding properties. With an impressive Martindale value of 150,000, it is extremely hard-wearing and resistant to abrasion.

Thanks to the use of carbon fibers, the fabric is permanently antistatic, which means that it hardly collects any dust and is therefore particularly easy to clean. Furthermore it is dirt-repellent and water and oil repellent, making it extremely resistant to soiling.

Another plus is its openness to diffusion, which means that the fabric enables excellent air and moisture exchange and thus counteracts the formation of mold.



Safety is a top priority with this fabric, as it is permanently fire-resistant - a property achieved by fire-retardant fibers. It therefore offers a high level of safety and protection.

For the environmentally conscious buyer, it is important to know that this fabric contains 37% recycled fibers, which contributes to the sustainable use of resources.

And to top it all off, the fabric manufacturer offers a generous 10-year guarantee against abrasion and pilling, which further reinforces confidence in the quality of this product.

The fabric also meets the requirements of the renowned STANDARD 100 by OEKO-TEX®, which means that it has been tested for harmful substances and is considered safe for human use.

Comfort-Specifications

Design no.	8580	
Composition	51% polyester/37% post-consumer rec.pes./12% polyurethane incl. antistatic fibers and fire retardant fibers in the backside	
Weight	g/lm 385 oz/lin.yd 12.42	
Width	cm 140 inches 55	
Abrasion	rubs martindale (EN ISO 12947-2) 150.000 Abrasion test results exceeding ACT Performance Guidelines are not an indicator of product lifespan	
Pilling	scale 1-5, max. 5 - EN ISO 12945-2	5
Light fastness	scale 1-8, max. 8 - EN ISO 105-B02	5-7
Rubbing fastness	scale 1-5, max. 5 - EN ISO 105x12 (dry/wet)	4/4-5
Care instructions	wash or dry cleaning P(W) most stains can be removed by brushing with a suede brush or using an eraser. or use a solution of luke-warm water and a neutral detergent. 74°C shrinkage max. 2,5%.  60°C shrinkage max. 2%. 	
Flammability	BS EN 1021 1&2 Cigarette and Match BS EN 1021-1 Cigarette ÖNORM A3800-B2-B3825-Q1 UK NF P 92-503 M3 CA TB 117-2013 Will also pass other flammability standards. Flame retardant performance is dependent upon the foam used.	
Environment	OEKO-TEX® STANDARD 100	

Gabriel Runner features

The Gabriel Runner fabric not only gives seating furniture an inviting and fascinating surface, but its colour palette also opens up a wide range of possible uses in the working environment and at home. Its design exudes comfort, elegance and robustness and can be perfectly combined with other Gabriel fabrics. 100% made from recyclable polyester, including 20% post-consumer recycled polyester, this fabric not only fulfils the demanding furniture facts requirements, but also proudly bears the EU Ecolabel and STANDARD 100 certification from OEKO-TEX®.

Runner-Specifications

Design no.	8705	
Composition	80% polyester / 20% post-consumer recycled polyester	
Weight	g/lm 510 oz/lin.yd 16.45	
Width	cm 160 inches 63	
Abrasion	rubs martindale (EN ISO 12947-2) 70,000 double rubs wyzenbeek (ASTM D4157) (heavy duty upholstery) 100,000 ASTM D4157-07 Wyz abrasion (heavy duty) pass Abrasion test results exceeding ACT Performance Guidelines are not an indicator of product lifespan	
Pilling	scale 1-5, max. 5 - EN ISO 12945-2 ASTM D3511 Pilling pass	5
Light fastness	scale 1-8, max. 8 - EN ISO 105-B02 AATCC 16 Lichtechtheit pass	5-7
Rubbing fastness	scale 1-5, max. 5 - EN ISO 105x12 (dry/wet) AATCC 8 oder 116 Nass-/Trocken-Crocking pass	4-5/4-5
Care instructions	wash or dry cleaning P(W). Runner is made of polyester which is a material suited for environments with special requirements for cleaning.  40°C shrinkage max. 5%.	
Flammability	CA TB 117-2013 BS EN 1021-1 Cigarette BS EN 1021 1&2 Cigarette and Match Will also pass other flammability standards. Flame retardant performance is dependent upon the foam used. Contains no flame retardant chemicals.	
Environment	OEKO-TEX® STANDARD 100 EU Ecolabel Cradle to Cradle Certified® Bronze	

Gabriel Cura features

The Cura fabric cover is characterized by a warm, casual aesthetic that is complemented by a lively melange effect and a soft, voluminous texture.

But this material is not only visually appealing - its high stretchability enables flexible use, making it perfect for office and lounge furniture. But what makes this material special is its sustainability. As much as 98% of the material is made from recycled post-consumer polyester, which makes a significant contribution to reducing waste. In addition, the entire material is 100% recyclable and therefore contributes to a closed-loop economy.

But this material also scores highly in terms of ecological standards. The EU Ecolabel shows that it meets strict environmental criteria and is therefore an environmentally friendly choice. It also fulfills the requirements of STANDARD 100 by OEKO-TEX®, which means that it has been tested for possible harmful substances and is considered safe for human use.

Cura-Specifications

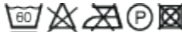
Design no.	2480/2544
Composition	100% post-consumer recycled polyester
Weight	g/lm 420 oz/lin.yd 55
Width	cm 140 inches 55
Abrasion	rubs Martindale (EN ISO 12947-2) 100.000 Double Rubs Wyzenbeek (ASTM D4157-07) (heavy duty upholstery) 100.000 ASTM D4157-07 Wyz-abrasion (heavy duty) 100k pass Abrasion test results exceeding ACT Performance Guidelines are not an indicator of product lifespan
Pilling	scale 1-5, max. 5 - EN ISO 12945-2 4-5 ASTM D3511 Pilling pass
Light fastness	scale 1-8, max. 8 - EN ISO 105-B02 5-8 AATCC 16 Light fastness pass
Rubbing fastness	scale 1-5, max. 5 - EN ISO 105x12 (dry/wet) 4-5/4-5 AATCC 8 oder 116 Dry/wet crocking pass
Care instructions	wash or dry cleaning P(W) Cura is made of polyester which is a material suited for environments with special requirements for cleaning.  40°C shrinkage max. 1%.  60°C shrinkage max. 2%.
Flammability	BS EN 1021 1&2 Cigarette and Match CA TB 117-2013 ASTM E 84 Class 1 Will also pass other flammability standards. Flame retardant performance is dependent upon the foam used. Contains no flame retardant chemicals.
Environment	OEKO-TEX® STANDARD 100 EU Ecolabel

Notes

Subject to technical change and model modifications. Colours may vary slightly from batch to batch. Freight costs on request. The valid general terms and conditions of Aeris GmbH apply. The Price List 04/2026 renders all previous price lists invalid. No liability is taken for errors, printing errors and changes in prices or product specifications. Please note, that not all products are available in all countries. If you have any questions, please contact the Aeris team.

Price overview

Aeris Swopper backrest

Backrest for the Aeris Swopper with castors (spring strut types Standard, Low, Light) retrofit. Prices of the Aeris Swopper backrest (base: plastic backrest panel) are determined by the different backrest covers.

Backrest	Aeris Swopper backrest Recommended retail price in EUR excl. VAT	Backrest cover sold separately accessory Recommended retail price in EUR excl. VAT
Without cover	€ 167.23	
Recycled post-consumer polyester (Cura, Gabriel)	€ 200.00	€ 49.58
Wool blend (Capture, Gabriel)	€ 208.40	€ 57.98
Wool blend (Select, Gabriel)	€ 208.40	€ 57.98
Microfibre (Comfort, Gabriel)	€ 216.81	€ 66.39
Mesh fabric (Runner, Gabriel)	€ 216.81	€ 66.39

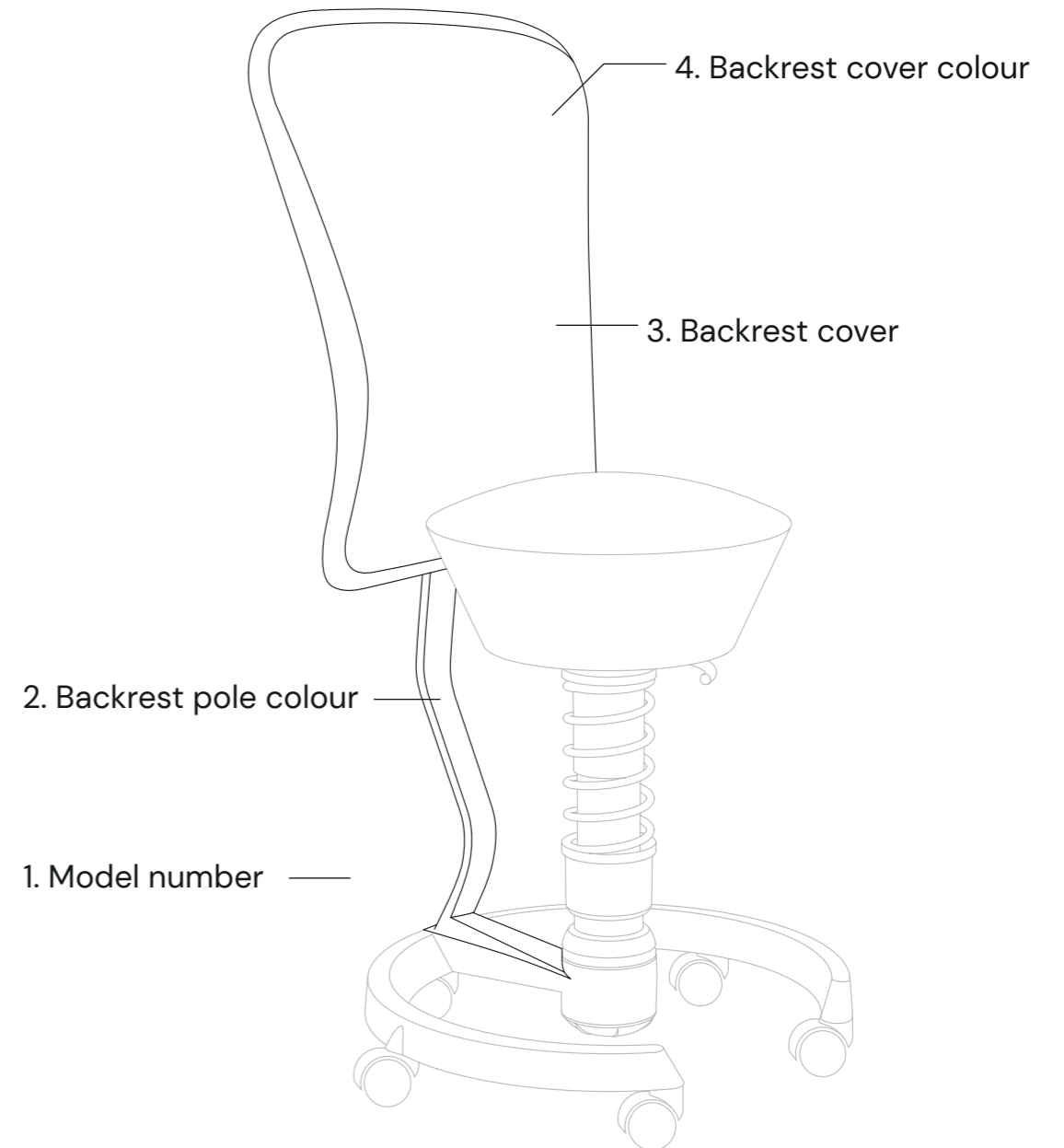

Components of the article number of the Aeris Swopper backrest easily explained.

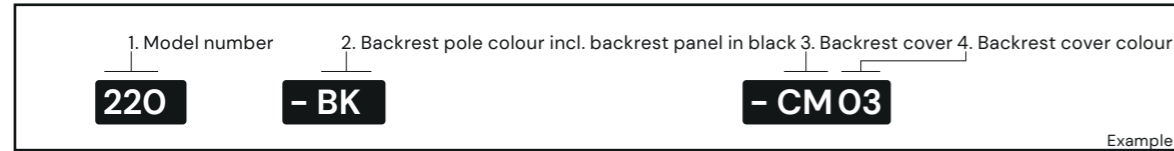

1. Model number

	Article code
Swopper backrest	220

2. Backrest pole colour

	Article code
black	-BK
white	-WH

3. Backrest cover

	Article code
Wool blend (Capture, Gabriel)	-CP
Wool blend (Select, Gabriel)	-SE
Recycled post-consumer polyester (Cura, Gabriel)	-CU
Mesh fabric (Runner, Gabriel)	-RN
Microfibre (Comfort, Gabriel)	-CM

4. Backrest cover colour

Please first choose the backrest cover colour for the Aeris Swopper backrest. The relevant article code (Aeris colour code) can be found on the following pages. Simply put it behind the article code of the backrest cover (without hyphen).

Article number Aeris Swopper backrest accessories



1. Model number

	Article code
Accessories backrest cover	221

2. Backrest cover

	Article code
Wool blend (Capture, Gabriel)	-CP
Wool blend (Select, Gabriel)	-SE
Recycled post-consumer polyester (Cura, Gabriel)	-CU
Mesh fabric (Runner, Gabriel)	-RN
Microfibre (Comfort, Gabriel)	-CM

3. Backrest cover colour

Please first choose the backrest cover colour for the Aeris Swopper backrest accessories. The relevant article code (Aeris colour code) can be found on the following pages. Simply put it behind the article code of the backrest cover (without hyphen).

Aeris Swopper backrest Fabric sample overview

Capture / Gabriel

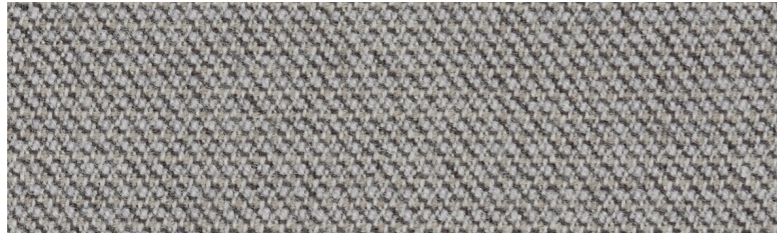

Select / Gabriel



Comfort / Gabriel



Runner / Gabriel



CP01, black
melange
5501

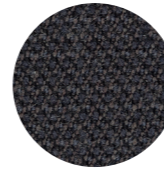

CP05, green
melange
5301

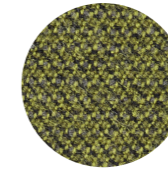

CP22, stone grey
melange
4102

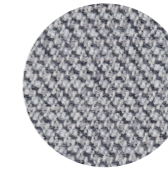

outlet fabric

SE01, black
60999

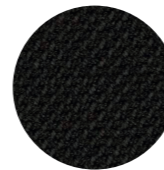

SE02, grey
60130



SE03, red
64089

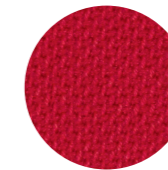

SE04, blue
66071

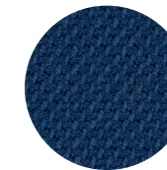

SE05, green
67095

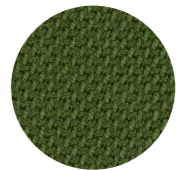

outlet fabric

outlet fabric

outlet fabric

CM01, black
0050

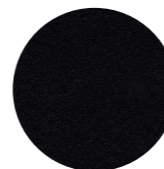

CM02, grey
1012

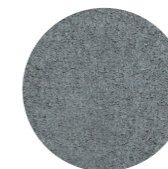

CM03, red
1414

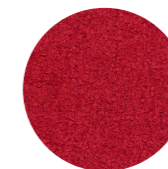

CM04, blue
66004

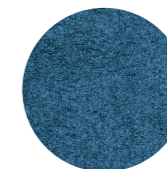

CM05, green
8397



RN01, black
60999

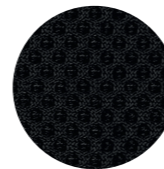

RN02, grey
60011

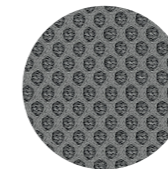

RN03, red
64119

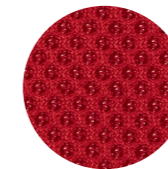

RN04, blue
66123

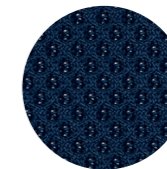

RN05, green
68110

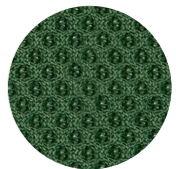

outlet fabric

outlet fabric

outlet fabric

Aeris Swopper backrest Fabric sample overview

Cura / Gabriel

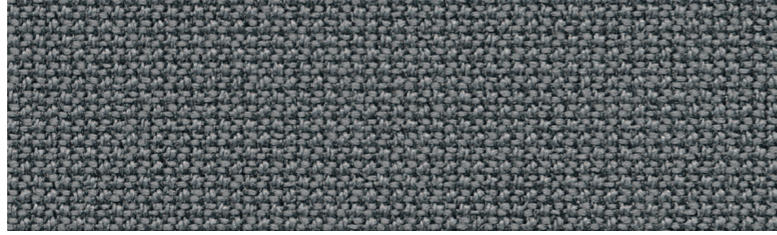

CU01, black

60111

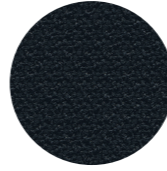

CU02, grey
melange

60110

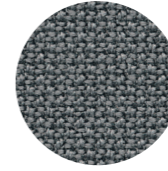

Gabriel Capture features

The use of lightly felted, multicolored wool in this material gives it a unique and appealing texture. The sophisticated melange pattern creates a fascinating look that immediately catches the eye. But not just visually, the feel of this material is also impressive across the board. The wool is incredibly soft and comfortable, which guarantees a pleasant and cozy sitting or reclining experience.

The outstanding wear resistance of this material guarantees a long service life and maintains its aesthetics even with regular use and stress. This makes it a durable choice that can withstand the high demands of daily use.

Finally, the Capture wool cover meets the demanding requirements of the furniture industry, which further underlines its quality and performance. It is therefore a reliable option that meets the standards of the furniture industry.

Capture-Specifications

Design no.	2472	
Composition	85% New Zealand wool / 15% polyamide	
Weight	g/lm 475 oz/lin.yd 15.32	
Width	cm 140 inches 55	
Abrasion	rubs martindale (EN ISO 12947-2) 200.000 rubs martindale (ASTM D4966) (heavy duty upholstery) 200.000 ASTM D4966 Martindale (heavy duty) pass Abrasion test results exceeding ACT Performance Guidelines are not an indicator of product lifespan	
Pilling	scale 1-5, max. 5 - EN ISO 12945-2 ASTM D4970 Pilling pass	4-5
Light fastness	scale 1-8, max. 8 - EN ISO 105-B02 AATCC 16 Light fastness pass	5-7
Rubbing fastness	scale 1-5, max. 5 - EN ISO 105x12 (dry/wet)	4-5/4-5
Care instructions	dry cleaning P(S) 	
Flammability	BS EN 1021 1&2 Cigarette and Match BS 5852 Part 1 O,1 Cigarette & Match, The Furniture and Furnishing Regulations 1988 Class Uno UNI 9175 Class 1 I EMME CA TB 117-2013 ASTM E 84 Class 1 Will also pass other flammability standards. Flame retardant performance is dependent upon the foam used. Contains no flame retardant chemicals.	
Environment	OEKO-TEX® STANDARD 100 EU Ecolabel	

Gabriel Select features

This impressive material boasts an elegant simplicity that is accompanied by an allround user-friendly design. With an extensive full spectrum color palette, it offers an almost endless variety of possibilities for design, making it fits perfectly with a wide variety of furnishing styles.

Thanks to its superior abrasion resistance, measured by an impressive 200,000 Martindale cycles, this material is extremely durable and resistant, even in heavy-duty environments. It is therefore an ideal choice for Highly frequented rooms such as public areas, offices or restaurants that require a durable solution.

The environmental friendliness of these materials is confirmed by the EU Ecolabel, which makes its production sustainable and environmentally friendly. It also fulfills the STANDARD 100 of OEKO-TEX®, which means that it has been tested for possible harmful substances is considered safe for human use.

Select-Specifications

Design no.	2498	
Composition	85% New Zealand wool / 15% polyamide	
Weight	g/lm 510 oz/lin.yd 16.45	
Width	cm 140 inches 55	
Abrasion	rubs martindale (EN ISO 12947-2) 200.000 ASTM D4966 Martindale (heavy duty) rubs martindale (ASTM D4966) (heavy duty upholstery) 100.000 Abrasion test results exceeding ACT Performance Guidelines are not an indicator of product lifespan	
Pilling	scale 1-5, max. 5 - EN ISO 12945-2 ASTM D4970 Pilling pass	4
Light fastness	scale 1-8, max. 8 - EN ISO 105-B02 AATCC 16 Light fastness pass	5-8
Rubbing fastness	scale 1-5, max. 5 - EN ISO 105x12 (dry/wet) AATCC 8 or 116 Dry/wet crocking	4-5/4-5 pass
Care instructions	dry cleaning P(S) 	
Flammability	BS EN 1021-1 Cigarette BS EN 1021-2 Match BS 5852 Part 1 O,1 Cigarette & Match, The Furniture and Furnishing Regulations 1988 BS 5852 Crib 5 IMO MSC 307(88) Annex 1 part 8 MED Certificate IMO IMO MSC 307(88) Annex 1 part 8 UK MED Certificate IMO UK CA TB 117-2013 Will also pass other flammability standards. Flame retardant performance is dependent upon the foam used. Contains no flame retardant chemicals..	
Environment	OEKO-TEX® STANDARD 100 EU Ecolabel	

Gabriel Comfort features

The high-quality fabric was specially developed for intensive use and has outstanding properties. With an impressive Martindale value of 150,000, it is extremely hard-wearing and resistant to abrasion.

Thanks to the use of carbon fibers, the fabric is permanently antistatic, which means that it hardly collects any dust and is therefore particularly easy to clean. Furthermore it is dirt-repellent and water and oil repellent, making it extremely resistant to soiling.

Another plus is its openness to diffusion, which means that the fabric enables excellent air and moisture exchange and thus counteracts the formation of mold.



Safety is a top priority with this fabric, as it is permanently fire-resistant - a property achieved by fire-retardant fibers. It therefore offers a high level of safety and protection.

For the environmentally conscious buyer, it is important to know that this fabric contains 37% recycled fibers, which contributes to the sustainable use of resources.

And to top it all off, the fabric manufacturer offers a generous 10-year guarantee against abrasion and pilling, which further reinforces confidence in the quality of this product.

The fabric also meets the requirements of the renowned STANDARD 100 by OEKO-TEX®, which means that it has been tested for harmful substances and is considered safe for human use.

Comfort-Specifications

Design no.	8580	
Composition	51% polyester/37% post-consumer rec.pes./12% polyurethane incl. antistatic fibers and fire retardant fibers in the backside	
Weight	g/lm 385 oz/lin.yd 12.42	
Width	cm 140 inches 55	
Abrasion	rubs martindale (EN ISO 12947-2) 150.000 Abrasion test results exceeding ACT Performance Guidelines are not an indicator of product lifespan	
Pilling	scale 1-5, max. 5 - EN ISO 12945-2	5
Light fastness	scale 1-8, max. 8 - EN ISO 105-B02	5-7
Rubbing fastness	scale 1-5, max. 5 - EN ISO 105x12 (dry/wet)	4/4-5
Care instructions	wash or dry cleaning P(W) most stains can be removed by brushing with a suede brush or using an eraser. or use a solution of luke-warm water and a neutral detergent. 74°C shrinkage max. 2,5%.  60°C shrinkage max. 2%. 	
Flammability	BS EN 1021 1&2 Cigarette and Match BS EN 1021-1 Cigarette ÖNORM A3800-B2-B3825-Q1 UK NF P 92-503 M3 CA TB 117-2013 Will also pass other flammability standards. Flame retardant performance is dependent upon the foam used.	
Environment	OEKO-TEX® STANDARD 100	

Gabriel Runner features

The Gabriel Runner fabric not only gives seating furniture an inviting and fascinating surface, but its colour palette also opens up a wide range of possible uses in the working environment and at home. Its design exudes comfort, elegance and robustness and can be perfectly combined with other Gabriel fabrics. 100% made from recyclable polyester, including 20% post-consumer recycled polyester, this fabric not only fulfils the demanding furniture facts requirements, but also proudly bears the EU Ecolabel and STANDARD 100 certification from OEKO-TEX®.

Runner-Specifications

Design no.	8705	
Composition	80% polyester / 20% post-consumer recycled polyester	
Weight	g/lm 510 oz/lin.yd 16.45	
Width	cm 160 inches 63	
Abrasion	rubs martindale (EN ISO 12947-2) 70,000 double rubs wyzenbeek (ASTM D4157) (heavy duty upholstery) 100,000 ASTM D4157-07 Wyz abrasion (heavy duty) pass Abrasion test results exceeding ACT Performance Guidelines are not an indicator of product lifespan	
Pilling	scale 1-5, max. 5 - EN ISO 12945-2 ASTM D3511 Pilling pass	5
Light fastness	scale 1-8, max. 8 - EN ISO 105-B02 AATCC 16 Lichtechtheit pass	5-7
Rubbing fastness	scale 1-5, max. 5 - EN ISO 105x12 (dry/wet) AATCC 8 oder 116 Nass-/Trocken-Crocking pass	4-5/4-5
Care instructions	wash or dry cleaning P(W). Runner is made of polyester which is a material suited for environments with special requirements for cleaning.  40°C shrinkage max. 5%.	
Flammability	CA TB 117-2013 BS EN 1021-1 Cigarette BS EN 1021 1&2 Cigarette and Match Will also pass other flammability standards. Flame retardant performance is dependent upon the foam used. Contains no flame retardant chemicals.	
Environment	OEKO-TEX® STANDARD 100 EU Ecolabel Cradle to Cradle Certified® Bronze	



Gabriel Cura features

The Cura fabric cover is characterized by a warm, casual aesthetic that is complemented by a lively melange effect and a soft, voluminous texture.

But this material is not only visually appealing - its high stretchability enables flexible use, making it perfect for office and lounge furniture. But what makes this material special is its sustainability. As much as 98% of the material is made from recycled post-consumer polyester, which makes a significant contribution to reducing waste. In addition, the entire material is 100% recyclable and therefore contributes to a closed-loop economy.

But this material also scores highly in terms of ecological standards. The EU Ecolabel shows that it meets strict environmental criteria and is therefore an environmentally friendly choice. It also fulfills the requirements of STANDARD 100 by OEKO-TEX®, which means that it has been tested for possible harmful substances and is considered safe for human use.

Cura-Specifications

Design no.	2480/2544
Composition	100% post-consumer recycled polyester
Weight	g/lm 420 oz/lin.yd 55
Width	cm 140 inches 55
Abrasion	rubs Martindale (EN ISO 12947-2) 100.000 Double Rubs Wyzenbeek (ASTM D4157-07) (heavy duty upholstery) 100.000 ASTM D4157-07 Wyz-abrasion (heavy duty) 100k pass Abrasion test results exceeding ACT Performance Guidelines are not an indicator of product lifespan
Pilling	scale 1-5, max. 5 - EN ISO 12945-2 4-5 ASTM D3511 Pilling pass
Light fastness	scale 1-8, max. 8 - EN ISO 105-B02 5-8 AATCC 16 Light fastness pass
Rubbing fastness	scale 1-5, max. 5 - EN ISO 105x12 (dry/wet) 4-5/4-5 AATCC 8 oder 116 Dry/wet crocking pass
Care instructions	wash or dry cleaning P(W) Cura is made of polyester which is a material suited for environments with special requirements for cleaning.  40°C shrinkage max. 1%.  60°C shrinkage max. 2%.
Flammability	BS EN 1021 1&2 Cigarette and Match CA TB 117-2013 ASTM E 84 Class 1 Will also pass other flammability standards. Flame retardant performance is dependent upon the foam used. Contains no flame retardant chemicals.
Environment	OEKO-TEX® STANDARD 100 EU Ecolabel

Notes

Subject to technical change and model modifications. Colours may vary slightly from batch to batch. Freight costs on request. The valid general terms and conditions of Aeris GmbH apply. The Price List 04/2026 renders all previous price lists invalid. No liability is taken for errors, printing errors and changes in prices or product specifications. Please note, that not all products are available in all countries. If you have any questions, please contact the Aeris team.

Price List

Aeris Swoppster

Seat cover	Frame Colour	Aeris Swoppster Recommended retail price in EUR excl. VAT
Polyester (Harlequin, Gabriel)	white	€ 276.47

Slip covers are also available separately as accessories.

Accessories	Recommended retail price in EUR excl. VAT
Slip cover (grey, pink, blue, green)	€ 41.18

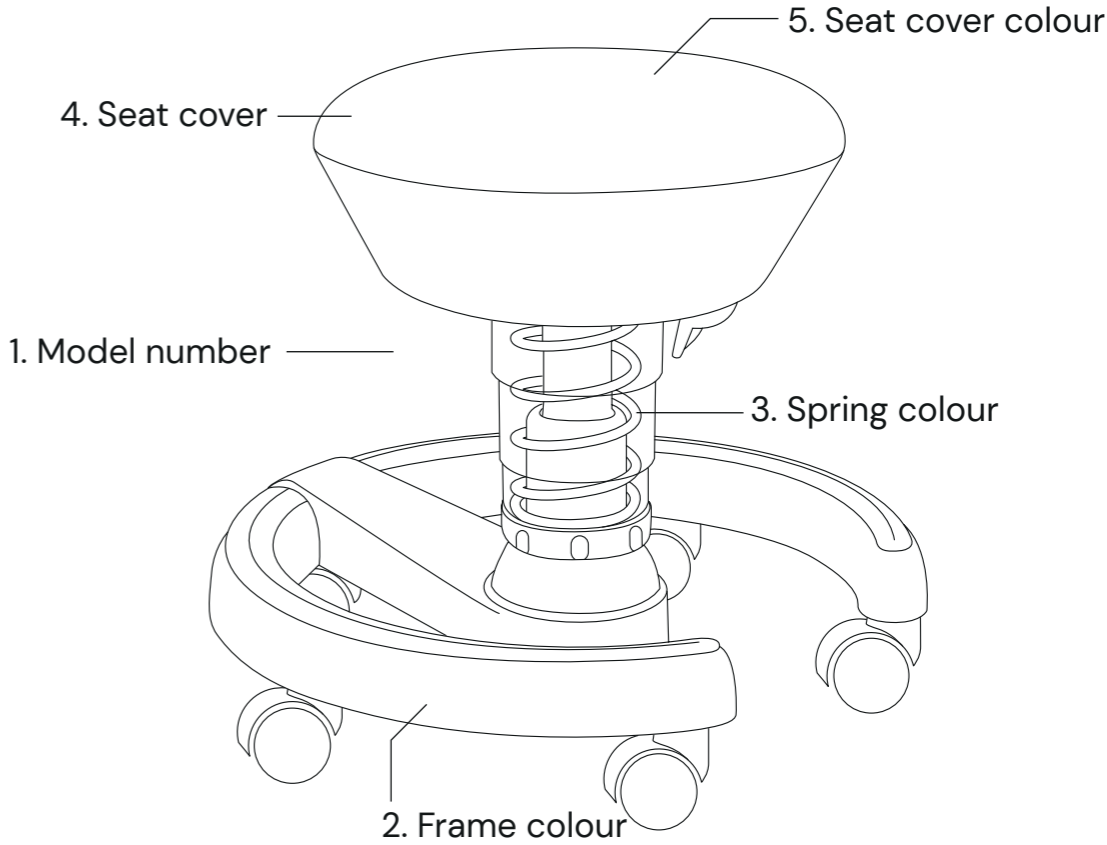

Components of the Aeris Swoppster article number easily explained.



1. Model number	Article code
Swoppster	120

2. Frame colour	Article code
white	- WH

3. Spring colour	Article code
white (only with white frame)	- WH

4. Seat cover	Article code
Polyester (Harlequin, Gabriel)	- HQ

5. Seat cover colour

Please first select the seat cover colour for the Aeris Swoppster. The relevant article code (Aeris colour code) can be found on the following pages. Simply put it behind the article code of the seat cover (without hyphen).

Article number Aeris Swoppster accessories

Accessories	Article number
Grey slip cover	125 - HQ02
Pink slip cover	125 - HQ03
Blue slip cover	125 - HQ04
Green slip cover	125 - HQ05

Aeris Swoppster Fabric sample overview

Harlequin, Gabriel



HQ02, grey
61188

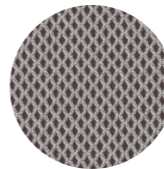

HQ03, pink
65117

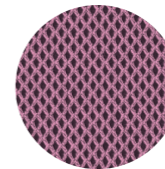

HQ04, blue
66141

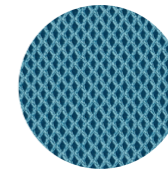

HQ05, green
68111

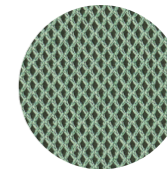

Gabriel Harlequin features

Made from 100% recyclable polyester, 23% of which is post-consumer recycled polyester, the Harlequin fabric cover is not only environmentally friendly but also durable. Its simple and streamlined appearance cuts a fine figure in any child's room.

In addition, the fabric fulfils important environmental standards such as the EU Ecolabel and STANDARD 100 by OEKO-TEX®, which means that it has been tested for harmful substances and found to be harmless.

Harlequin-Specifications

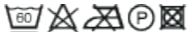
Design-Nr.	8707
Composition	77% polyester / 23% post-consumer recycled polyeste
Weight	g/lm 510 oz/lin.yd 16,45
Width	cm 160 inches 63
Abrasion	rubs martindale (EN ISO 12947-2) 100.000 double rubs wyzenbeek (ASTM D4157) (heavy duty upholstery) 100.000
Pilling	scale 1-5, max. 5 - EN ISO 12945-2 5 ASTM D3511 Pilling pass
Light fastness	scale 1-8, max. 8 - EN ISO 105-B02 5-7 AATCC 16 Light fastness pass
Rubbing fastness	scale 1-5, max. 5 - EN ISO 105x12 (dry/wet) 4-5/4-5
Care instructions	wash or dry cleaning P(W). Harlequin is made of polyester which is a material suited for environments with special requirements for cleaning.  40°C shrinkage max. 4,0%.  60°C shrinkage max. 5,0%.
Flammability	BS EN 1021 1&2 Cigarette and Match CA TB 117-2013 Will also pass other flammability standards. Flame retardant performance is dependent upon the foam used. Contains no flame retardant chemicals.
Environment	OEKO-TEX® STANDARD 100 EU Ecolabel Cradle to Cradle Certified® Bronze

Notes

Subject to technical change and model modifications.
Colours may vary slightly from batch to batch. Freight costs on request. The valid general terms and conditions of Aeris GmbH apply. The Price List 04/2026 renders all previous price lists invalid. No liability is taken for errors, printing errors and changes in prices or product specifications. Please note, that not all products are available in all countries. If you have any questions, please contact the Aeris team.

Price List

Aeris 3Dee

The Aeris 3Dee prices are determined by the different seat and backrest covers.

Seat and backrest cover	Aeris 3Dee (black, white frame) Recommended retail price in EUR excl. VAT
Recycled Post-Consumer Polyester (Cura, Gabriel)	€ 805.88
Microfibre (Comfort, Gabriel)	€ 839.50

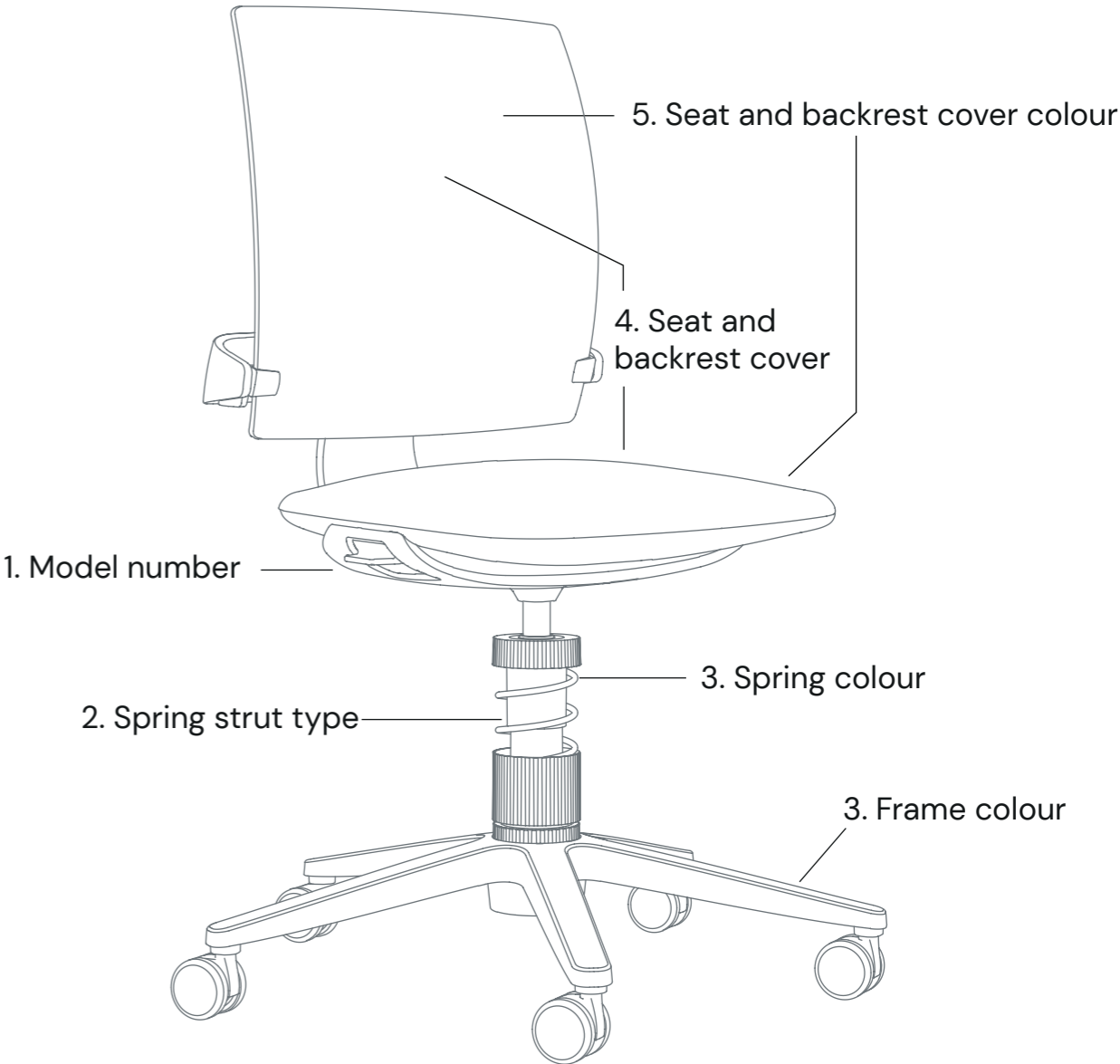

Components of the Aeris 3Dee article number easily explained.



1. Model number	
	Article code
3Dee	932

2. Spring strut type	
	Article code
Standard*: Body weight: 50 - 120 kg Height adjustment range under load: 48 - 57 cm Height adjustment range without load: 52,5 - 61,5 cm	- ST

* According to DIN EN 1335

3. Frame and spring colour	
	Article code
Frame colour: black Spring colour: black	BK
Frame colour: white Spring colour: white	WH

4. Seat and backrest cover	
	Article code
Recycled Post-Consumer Polyester (Cura, Gabriel)	- CU
Microfibre (Comfort, Gabriel)	- CM

5. Seat and backrest cover colour

Please first select the seat and backrest cover colour for the Aeris 3Dee. The relevant article code (Aeris colour code) can be found on the following pages. Simply put it behind the article code of the seat and backrest cover (without hyphen).

Aeris 3Dee Fabric sample overview

Comfort / Gabriel



Cura / Gabriel

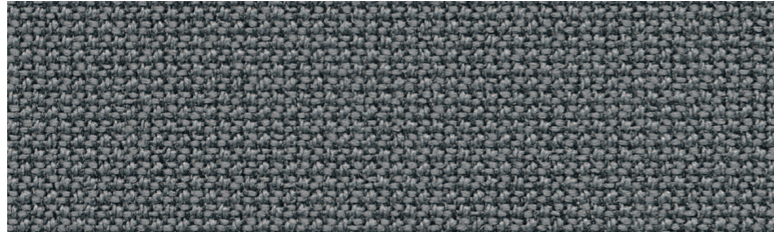

CM01, black
0050

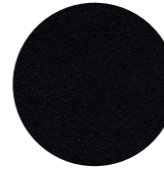

CM02, grey
1012

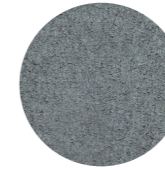

CM03, red
1414

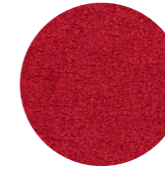

CM04, blue
66004

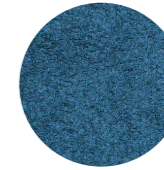

CM05, green
8397

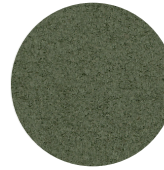

CU01, black
60111

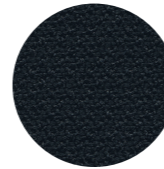

CU02, grey
melange
60110

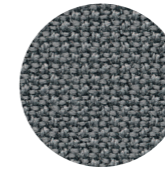

CU04, blue
melange
66167

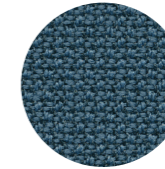

CU14, fern green
melange
68181

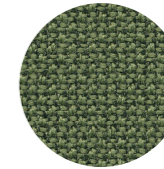

CU17, light grey
melange
60112

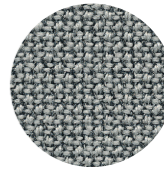

Gabriel Comfort features

The high-quality fabric was specially developed for intensive use and has outstanding properties. With an impressive Martindale value of 150,000, it is extremely hard-wearing and resistant to abrasion.

Thanks to the use of carbon fibers, the fabric is permanently antistatic, which means that it hardly collects any dust and is therefore particularly easy to clean. Furthermore it is dirt-repellent and water and oil repellent, making it extremely resistant to soiling.

Another plus is its openness to diffusion, which means that the fabric enables excellent air and moisture exchange and thus counteracts the formation of mold.



Safety is a top priority with this fabric, as it is permanently fire-resistant - a property achieved by fire-retardant fibers. It therefore offers a high level of safety and protection.

For the environmentally conscious buyer, it is important to know that this fabric contains 37% recycled fibers, which contributes to the sustainable use of resources.

And to top it all off, the fabric manufacturer offers a generous 10-year guarantee against abrasion and pilling, which further reinforces confidence in the quality of this product.

The fabric also meets the requirements of the renowned STANDARD 100 by OEKO-TEX®, which means that it has been tested for harmful substances and is considered safe for human use.

Comfort-Specifications

Design no.	8580
Composition	51% polyester/37% post-consumer rec.pes./12% polyurethane incl. antistatic fibers and fire retardant fibers in the backside
Weight	g/lm 385 oz/lin.yd 12.42
Width	cm 140 inches 55
Abrasion	rubs martindale (EN ISO 12947-2) 150.000 Abrasion test results exceeding ACT Performance Guidelines are not an indicator of product lifespan
Pilling	scale 1-5, max. 5 - EN ISO 12945-2 5
Light fastness	scale 1-8, max. 8 - EN ISO 105-B02 5-7
Rubbing fastness	scale 1-5, max. 5 - EN ISO 105x12 (dry/wet) 4/4-5
Care instructions	wash or dry cleaning P(W) most stains can be removed by brushing with a suede brush or using an eraser. or use a solution of luke-warm water and a neutral detergent. 74°C shrinkage max. 2,5%.  60°C shrinkage max. 2%. 
Flammability	BS EN 1021 1&2 Cigarette and Match BS EN 1021-1 Cigarette ÖNORM A3800-B2-B3825-Q1 UK NF P 92-503 M3 CA TB 117-2013 Will also pass other flammability standards. Flame retardant performance is dependent upon the foam used.
Environment	OEKO-TEX® STANDARD 100



Gabriel Cura features

The Cura fabric cover is characterized by a warm, casual aesthetic that is complemented by a lively melange effect and a soft, voluminous texture.

But this material is not only visually appealing - its high stretchability enables flexible use, making it perfect for office and lounge furniture. But what makes this material special is its sustainability. As much as 98% of the material is made from recycled post-consumer polyester, which makes a significant contribution to reducing waste. In addition, the entire material is 100% recyclable and therefore contributes to a closed-loop economy.

But this material also scores highly in terms of ecological standards. The EU Ecolabel shows that it meets strict environmental criteria and is therefore an environmentally friendly choice. It also fulfills the requirements of STANDARD 100 by OEKO-TEX®, which means that it has been tested for possible harmful substances and is considered safe for human use.

Cura-Specifications

Design no.	2480/2544
Composition	100% post-consumer recycled polyester
Weight	g/lm 420 oz/lin.yd 55
Width	cm 140 inches 55
Abrasion	rubs Martindale (EN ISO 12947-2) 100.000 Double Rubs Wyzenbeek (ASTM D4157-07) (heavy duty upholstery) 100.000 ASTM D4157-07 Wyz-abrasion (heavy duty) 100k pass Abrasion test results exceeding ACT Performance Guidelines are not an indicator of product lifespan
Pilling	scale 1-5, max. 5 - EN ISO 12945-2 4-5 ASTM D3511 Pilling pass
Light fastness	scale 1-8, max. 8 - EN ISO 105-B02 5-8 AATCC 16 Light fastness pass
Rubbing fastness	scale 1-5, max. 5 - EN ISO 105x12 (dry/wet) 4-5/4-5 AATCC 8 oder 116 Dry/wet crocking pass
Care instructions	wash or dry cleaning P(W) Cura is made of polyester which is a material suited for environments with special requirements for cleaning.  40°C shrinkage max. 1%.  60°C shrinkage max. 2%.
Flammability	BS EN 1021 1&2 Cigarette and Match CA TB 117-2013 ASTM E 84 Class 1 Will also pass other flammability standards. Flame retardant performance is dependent upon the foam used. Contains no flame retardant chemicals.
Environment	OEKO-TEX® STANDARD 100 EU Ecolabel

Notes

Subject to technical change and model modifications. Colours may vary slightly from batch to batch. Freight costs on request. The valid general terms and conditions of Aeris GmbH apply. The Price List 04/2026 renders all previous price lists invalid. No liability is taken for errors, printing errors and changes in prices or product specifications. Please note, that not all products are available in all countries. If you have any questions, please contact the Aeris team.

Price List

Aeris Linu

The Aeris Linu prices are determined by the models (Conference, Task) and the seat and backrest cover.

Aeris Linu Conference (skid base)

Frame colour	With seat and backrest cover Recommended retail price in EUR excl. VAT
black	€ 444.54

Aeris Linu Conference (4-star base)

Frame colour	With seat and backrest cover with gliders Recommended retail price in EUR excl. VAT
black	€ 528.57

Aeris Linu Task (column)

Frame colour	With seat and backrest cover with gliders or casters Recommended retail price in EUR excl. VAT
black	€ 503.36

Aeris Linu Task (spring strut)

Frame colour	With seat and backrest cover with gliders or casters Recommended retail price in EUR excl. VAT
black	€ 621.01

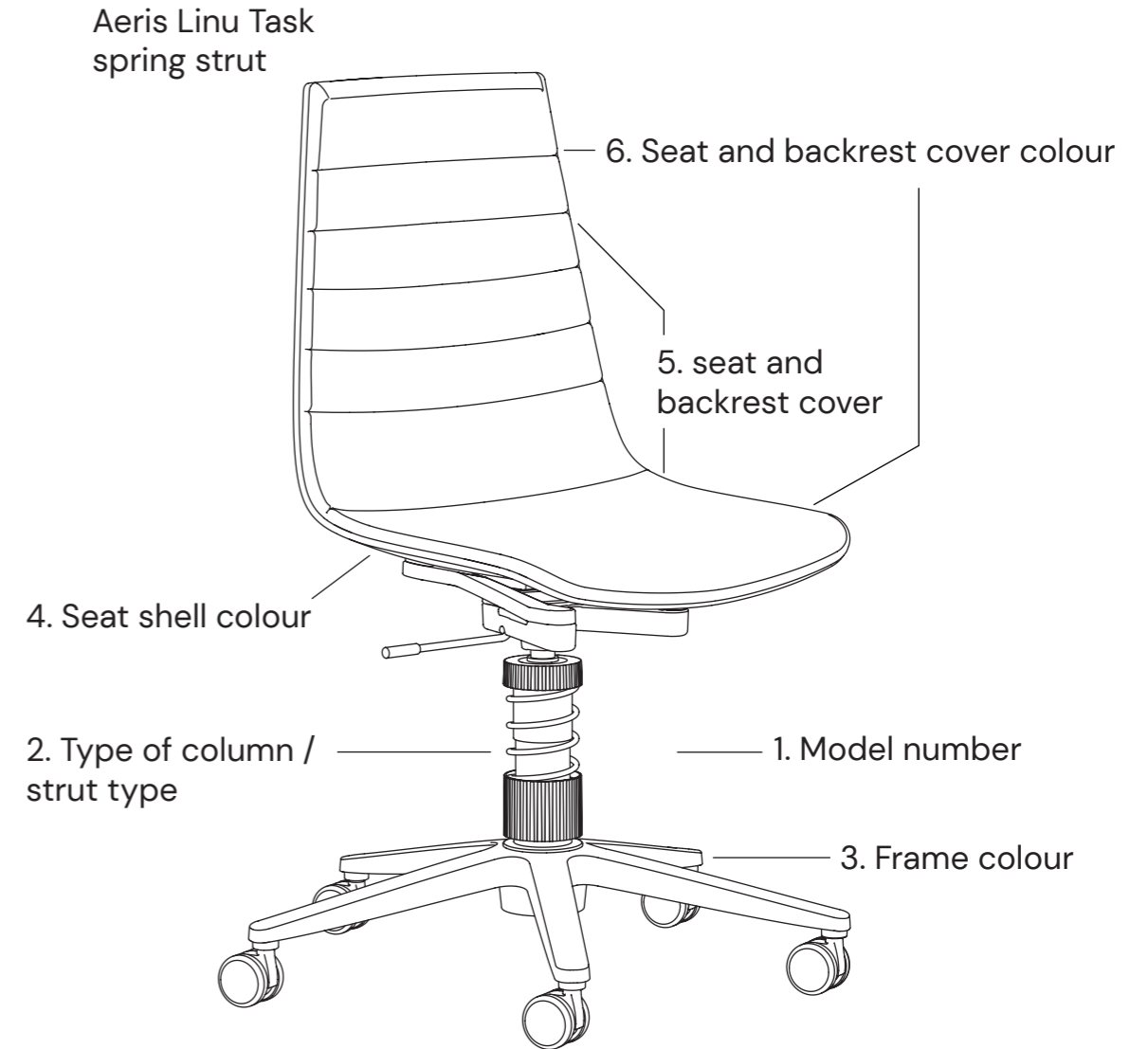

Aeris Linu Conference
skid base



Aeris Linu Conference
4-star base



Aeris Linu Task
column

The article number composition of the Aeris Linu Conference simply explained.

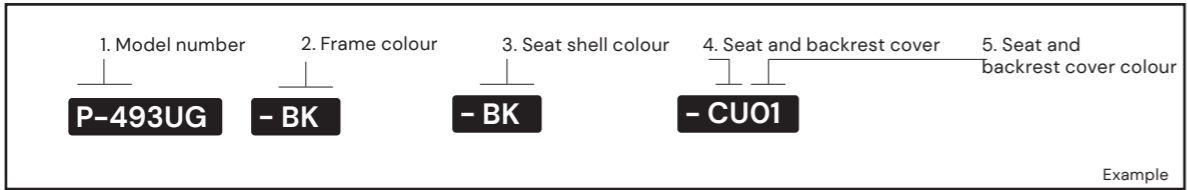

1. Model number	Article code
Conference skid base	P-491
Conference 4-star base with gliders	P-493UG

2. Frame colour	Article code
black	- BK

3. Seat shell colour	Article code
black	- BK

4. Seat and backrest cover	Article code
Recycled post-consumer polyester (Cura, Gabriel)	- CU

5. Seat and backrest cover colour

The relevant article code (Aeris colour code) can be found on the following pages. Simply put it behind the article code of the seat cover (without hyphen).

The article number composition of the Aeris Linu Task simply explained.

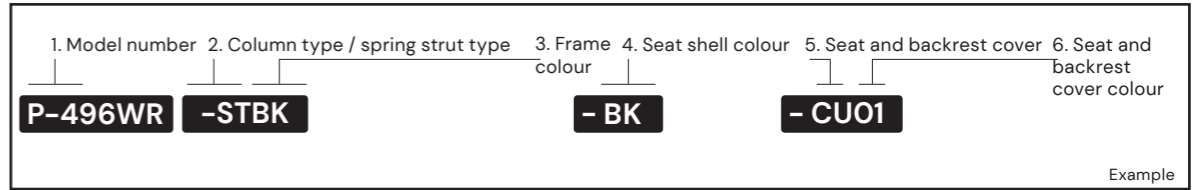

1. Model number	Article code
Task column with casters	P-494WR
Task spring strut with castors	P-496WR
Task column with glides	P-494UG
Task spring strut with glides	P-496UG

2. Column type	Article code
Standard*: Body weight 45-120 kg Seat height: 42-55 cm	- ST

*Only for the model with column

2. Spring strut type	Article code
Standard*: Body weight: 60 - 120 kg Seat height when loaded: 43-51.5 cm Seat height when unloaded: 53-61.5 cm	- ST

*Only for the model with spring strut

3. Frame colour	Article code
black	BK

4. Seat shell colour	Article code
black	- BK

5. Seat and backrest cover	Article code
Recycled post-consumer polyester (Cura, Gabriel)	- CU

6. Seat and backrest cover colour

The relevant article code (Aeris colour code) can be found on the following pages. Simply put it behind the article code of the seat cover (without hyphen).

Aeris Linu Fabric sample overview

Cura / Gabriel

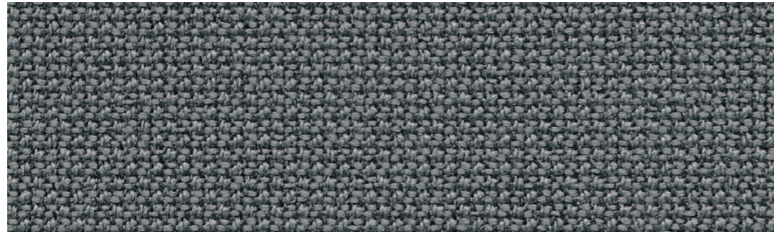

CU01, black

60111

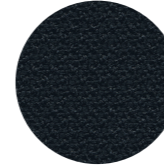

CU02, grey
melange

60110

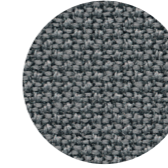

CU04, blue
melange

66167

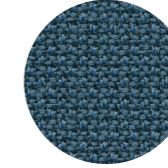

CU14, fern green
melange

68181

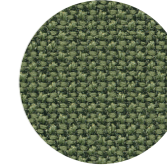

CU17, light grey
melange

60112

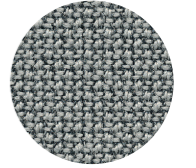



Gabriel Cura features

The Cura fabric cover is characterized by a warm, casual aesthetic that is complemented by a lively melange effect and a soft, voluminous texture.

But this material is not only visually appealing - its high stretchability enables flexible use, making it perfect for office and lounge furniture. But what makes this material special is its sustainability. As much as 98% of the material is made from recycled post-consumer polyester, which makes a significant contribution to reducing waste. In addition, the entire material is 100% recyclable and therefore contributes to a closed-loop economy.

But this material also scores highly in terms of ecological standards. The EU Ecolabel shows that it meets strict environmental criteria and is therefore an environmentally friendly choice. It also fulfills the requirements of STANDARD 100 by OEKO-TEX®, which means that it has been tested for possible harmful substances and is considered safe for human use.

Cura-Specifications

Design no.	2480/2544
Composition	100% post-consumer recycled polyester
Weight	g/lm 420 oz/lin.yd 55
Width	cm 140 inches 55
Abrasion	rubs Martindale (EN ISO 12947-2) 100.000 Double Rubs Wyzenbeek (ASTM D4157-07) (heavy duty upholstery) 100.000 ASTM D4157-07 Wyz-abrasion (heavy duty) 100k pass Abrasion test results exceeding ACT Performance Guidelines are not an indicator of product lifespan
Pilling	scale 1-5, max. 5 - EN ISO 12945-2 4-5 ASTM D3511 Pilling pass
Light fastness	scale 1-8, max. 8 - EN ISO 105-B02 5-8 AATCC 16 Light fastness pass
Rubbing fastness	scale 1-5, max. 5 - EN ISO 105x12 (dry/wet) 4-5/4-5 AATCC 8 oder 116 Dry/wet crocking pass
Care instructions	wash or dry cleaning P(W) Cura is made of polyester which is a material suited for environments with special requirements for cleaning.  40°C shrinkage max. 1%.  60°C shrinkage max. 2%.
Flammability	BS EN 1021 1&2 Cigarette and Match CA TB 117-2013 ASTM E 84 Class 1 Will also pass other flammability standards. Flame retardant performance is dependent upon the foam used. Contains no flame retardant chemicals.
Environment	OEKO-TEX® STANDARD 100 EU Ecolabel

Notes

Subject to technical change and model modifications. Colours may vary slightly from batch to batch. Freight costs on request. The valid general terms and conditions of Aeris GmbH apply. The Price List 04/2026 renders all previous price lists invalid. No liability is taken for errors, printing errors and changes in prices or product specifications. Please note, that not all products are available in all countries. If you have any questions, please contact the Aeris team.

Price List

Aeris Numo

The Aeris Numo prices are determined by the type of frame (skids, wooden legs, 4-star base) and the different colours of frame and kinematics.

Aeris Numo skid base

Frame colour	Recommended retail price in EUR excl. VAT
white, black	€ 335.29
chrome polished (outlet)	€ 360.50

Aeris Numo wooden legs

Kinematics colour	Recommended retail price in EUR excl. VAT
white, black	€ 419.33
high gloss polished (outlet)	€ 444.54

Aeris Numo 4-star base

Frame and kinematics colour	4-star base with glides Recommended retail price in EUR excl. VAT	4-star base with castors Recommended retail price in EUR excl. VAT
white, black	€ 452.94	€ 478.15
high gloss polished (outlet)	€ 478.15	€ 503.36

Accessories: Aeris Numo seat cushion

	Recommended retail price in EUR excl. VAT
Recycled Post-Consumer Polyester (Cura, Gabriel)	€ 49.58

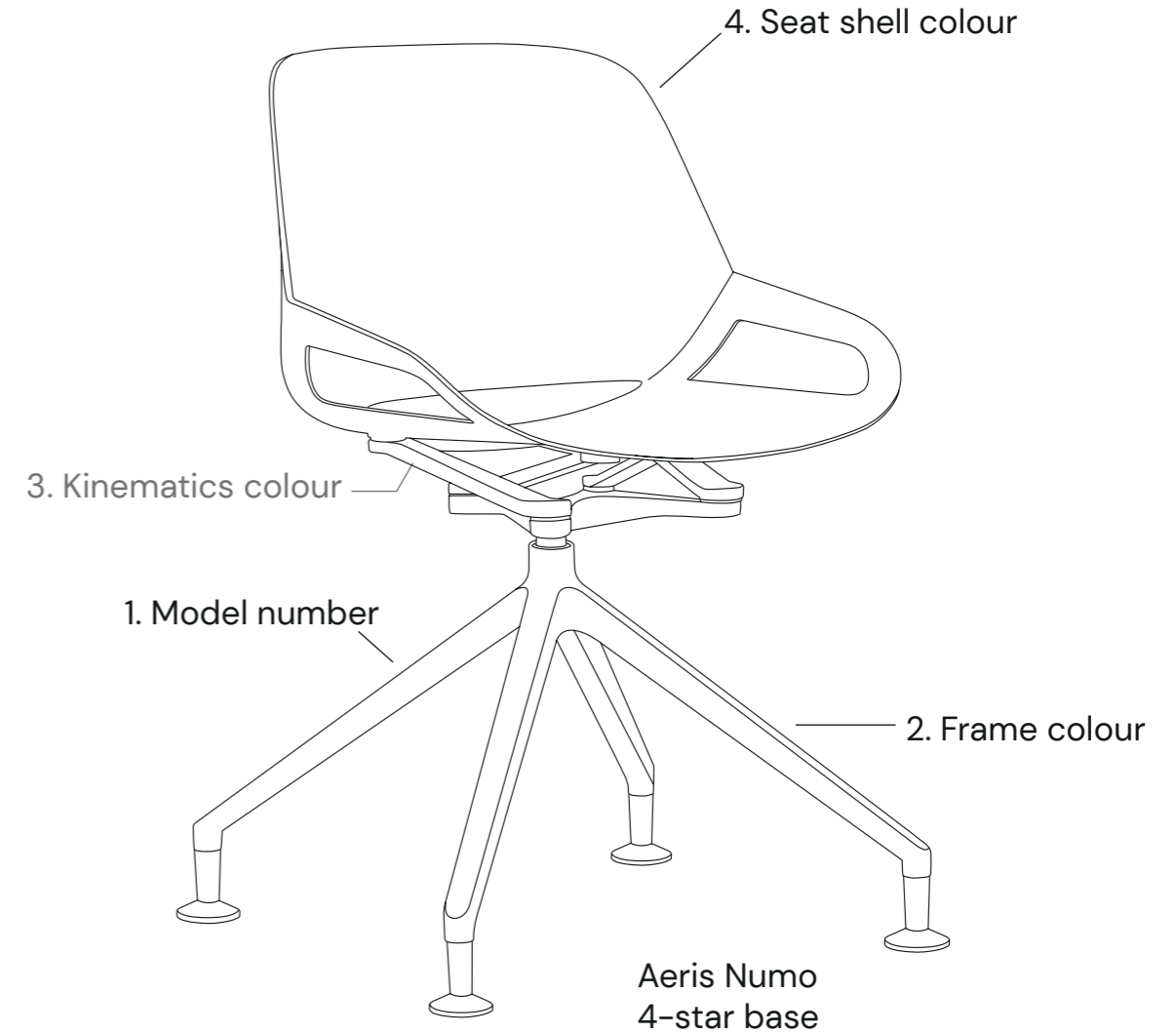

Aeris Numo
skid base



Aeris Numo
wooden legs

Components of the Aeris Numo article number easily explained.



1. Model number

	Article code
Skid base	461
Wooden legs	462
4-star base with glides	463UG
4-star base with castors	463WR

3. Kinematics colour

(only on the model with wooden legs and 4-star base)

	Article code
white	- WH
black	- BK
high gloss polished	- PL

Note: white and black kinematics can only be combined with the same frame (white or black).

2. Frame colour

	Article code
white*	- WH
black*	- BK
chrome polished**	- CR
natural oak (only for the model with wooden legs)	- OA
high gloss polished (only for the model with 4-star base)	- PL

* Not available for the model with wooden legs.

** Available only for the model with skid base.

4. Seat shell colour

	Article code
white	- WH
black	- BK

Note: For the Aeris Numo skid base: the coloured frame (white, black) can only be combined with the same seat shell colour.

Components of the article number of the Aeris Numo seat cushion easily explained.

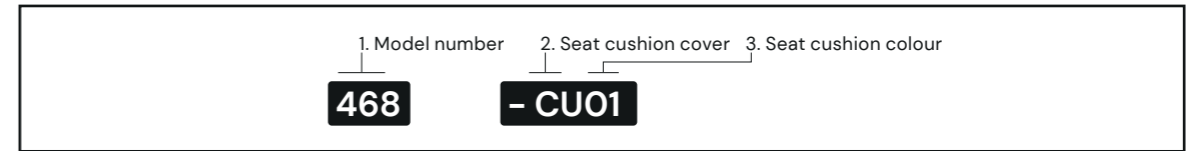

1. Model number

	Article code
Seat cushion	468

2. Seat cushion cover

	Article code
Recycled Post-Consumer Polyester (Cura, Gabriel)	- CU

3. Seat cushion colour

Please first choose the seat cushion cover colour for the Aeris Numo seat cushion. The relevant article code (Aeris colour number) can be found below. Simply put it behind the article code of the seat cushion cover (without hyphen).

Aeris Numo Fabric sample overview

Cura / Gabriel

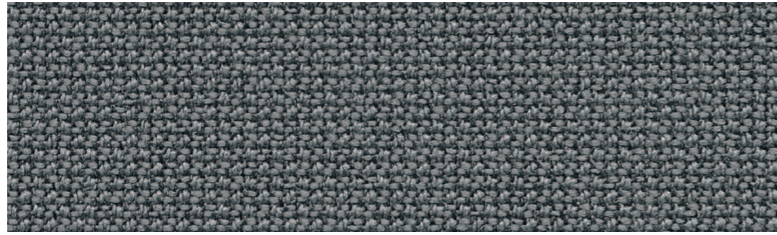

CU01, black

60111

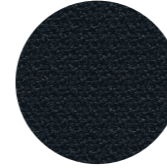

CU02, grey
melange

60110

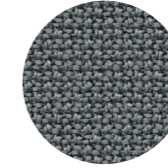

CU04, blue
melange

66167

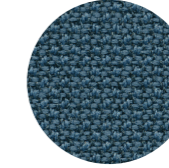

CU14, fern green
melange

68181

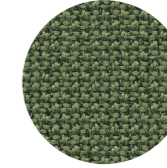

CU17, light grey
melange

60112

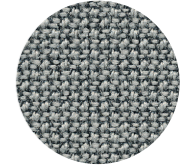

Gabriel Cura features

The Cura fabric cover is characterized by a warm, casual aesthetic that is complemented by a lively melange effect and a soft, voluminous texture.

But this material is not only visually appealing - its high stretchability enables flexible use, making it perfect for office and lounge furniture. But what makes this material special is its sustainability. As much as 98% of the material is made from recycled post-consumer polyester, which makes a significant contribution to reducing waste. In addition, the entire material is 100% recyclable and therefore contributes to a closed-loop economy.

But this material also scores highly in terms of ecological standards. The EU Ecolabel shows that it meets strict environmental criteria and is therefore an environmentally friendly choice. It also fulfills the requirements of STANDARD 100 by OEKO-TEX®, which means that it has been tested for possible harmful substances and is considered safe for human use.

Cura-Specifications

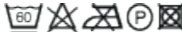
Design no.	2480/2544
Composition	100% post-consumer recycled polyester
Weight	g/lm 420 oz/lin.yd 55
Width	cm 140 inches 55
Abrasion	rubs Martindale (EN ISO 12947-2) 100.000 Double Rubs Wyzenbeek (ASTM D4157-07) (heavy duty upholstery) 100.000 ASTM D4157-07 Wyz-abrasion (heavy duty) 100k pass Abrasion test results exceeding ACT Performance Guidelines are not an indicator of product lifespan
Pilling	scale 1-5, max. 5 - EN ISO 12945-2 4-5 ASTM D3511 Pilling pass
Light fastness	scale 1-8, max. 8 - EN ISO 105-B02 5-8 AATCC 16 Light fastness pass
Rubbing fastness	scale 1-5, max. 5 - EN ISO 105x12 (dry/wet) 4-5/4-5 AATCC 8 oder 116 Dry/wet crocking pass
Care instructions	wash or dry cleaning P(W) Cura is made of polyester which is a material suited for environments with special requirements for cleaning.  40°C shrinkage max. 1%.  60°C shrinkage max. 2%.
Flammability	BS EN 1021 1&2 Cigarette and Match CA TB 117-2013 ASTM E 84 Class 1 Will also pass other flammability standards. Flame retardant performance is dependent upon the foam used. Contains no flame retardant chemicals.
Environment	OEKO-TEX® STANDARD 100 EU Ecolabel

Notes

Subject to technical change and model modifications. Colours may vary slightly from batch to batch. Freight costs on request. The valid general terms and conditions of Aeris GmbH apply. The Price List 04/2026 renders all previous price lists invalid. No liability is taken for errors, printing errors and changes in prices or product specifications. Please note, that not all products are available in all countries. If you have any questions, please contact the Aeris team.

Price List

Aeris Numo Comfort

The Aeris Numo Comfort prices are determined by the type of frame (skid base, wooden legs, 4-star base), the frame colours, the seat cover and the optional backrest cushion.

Aeris Numo Comfort skid base

Cover	Frame colour	Without backrest padding Recommended retail price in EUR excl. VAT	With backrest padding Recommended retail price in EUR excl. VAT
Recycled post-consumer polyester (Cura, Gabriel)	white, black	€ 410.92	€ 452.94
	chrome polished (outlet)	€ 436.13	€ 478.15
Artificial leather (Mediflex, Monteiro)	white, black	€ 419.33	€ 469.75

Aeris Numo Comfort wooden legs

Cover	Frame and kinematic colour	Without backrest padding Recommended retail price in EUR excl. VAT	With backrest padding Recommended retail price in EUR excl. VAT
Recycled post-consumer polyester (Cura, Gabriel)	white, black	€ 469.75	€ 511.76
	high gloss polished (outlet)	€ 494.96	€ 536.97
Artificial leather (Mediflex, Monteiro)	white, black	€ 478.15	€ 528.57

Aeris Numo Comfort 4-star base

Cover	Frame and kinematic colour	Without backrest padding Recommended retail price in EUR excl. VAT	With backrest padding Recommended retail price in EUR excl. VAT
Recycled post-consumer polyester (Cura, Gabriel)	white, black	€ 528.57	€ 570.59
	high gloss polished (outlet)	€ 553.78	€ 595.80
Artificial leather (Mediflex, Monteiro)	white, black	€ 536.97	€ 587.39

Backrest padding	Recommended retail price in EUR excl. VAT
Recycled post-consumer polyester (Cura, Gabriel)	€ 57.98
Artificial leather (Mediflex, Monteiro)	€ 66.39

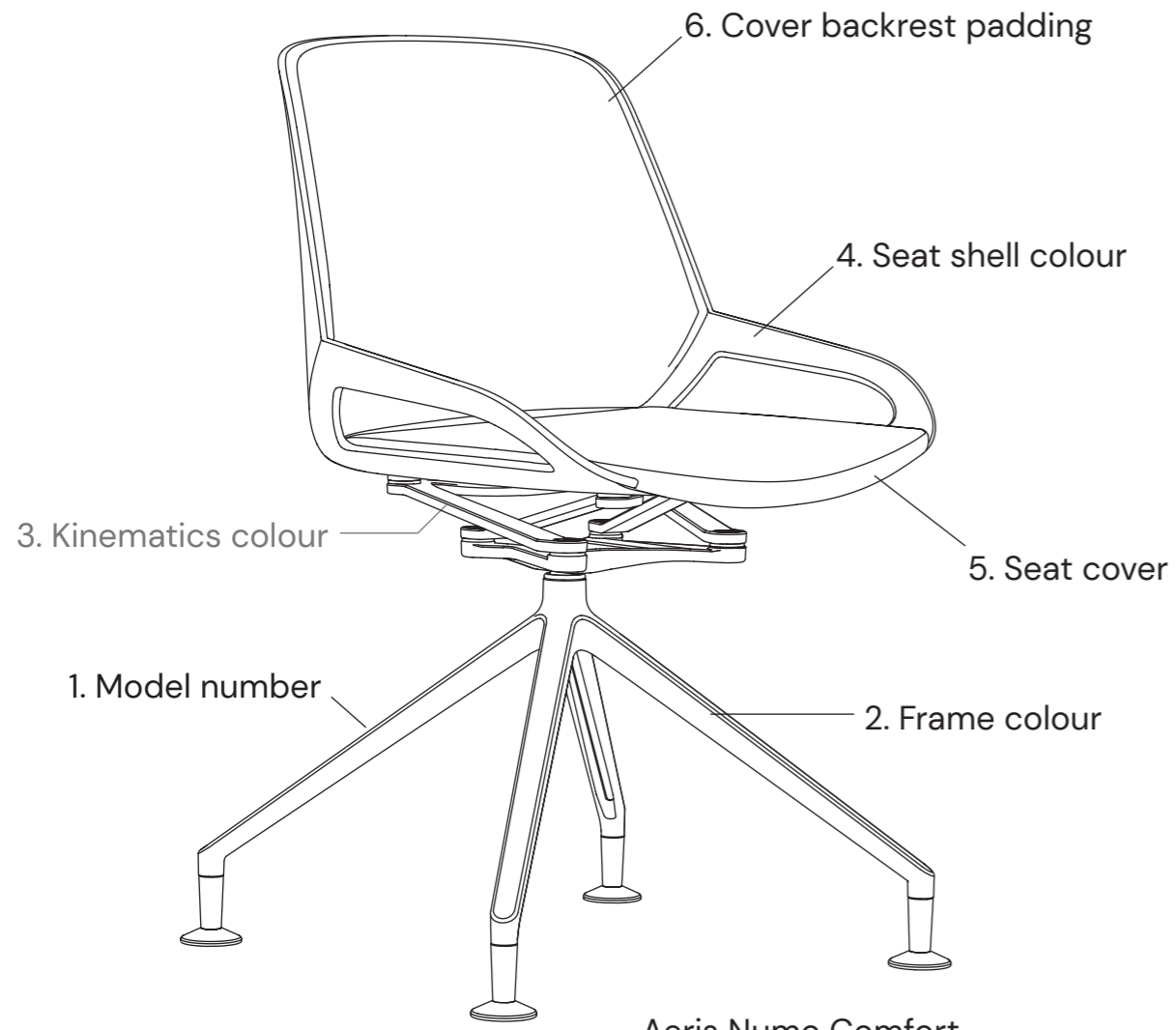

Aeris Numo Comfort
4-star base



Aeris Numo Comfort
skid base



Aeris Numo Comfort
wooden legs

Components of the Aeris Numo Comfort article number easily explained.

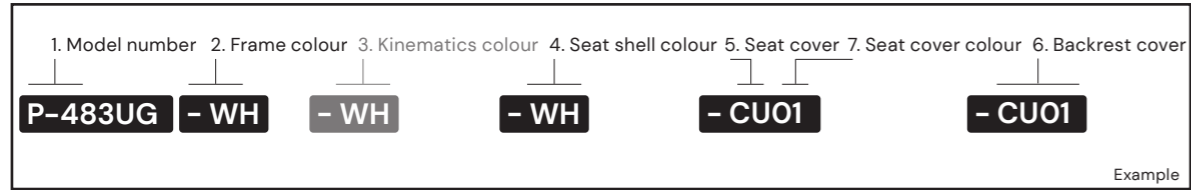

1. Model number	Article code
Skid base	P-481
Wooden legs	P-482
4-star base with glides	P-483UG

4. Seat shell colour	Article code
white	- WH
black	- BK

Note: For the Aeris Numo Comfort skid base: the coloured frame (white, black) can only be combined with the same seat shell colour.

2. Frame colour	Article code
white*	- WH
black*	- BK
chrome polished**	- CR
natural oak (only for the model with wooden legs)	- OA
high gloss polished (only for the model with 4-star base)	- PL

5. Seat cover	Article code
Recycled Post-Consumer Polyester (Cura, Gabriel)	- CU
Artificial leather(Mediflex, Monteiro)	- ME

6. Backrest cover*	Article code
Recycled Post-Consumer Polyester (Cura, Gabriel)	- CU
Artificial leather(Mediflex, Monteiro)	- ME

*Optional. The colour of the backrest cover can only be selected to match the seat cover.

3. Kinematics colour (only on the model with wooden legs and 4-star base)	Article code
white	- WH
black	- BK
high gloss polished	- PL

7. Seat cover colour	Article code
----------------------	--------------

The article code (= colour number Aeris) can be found on page 5. Simply add this to the article code of the seat cover (without hyphen).

Note: white and black kinematics can only be combined with the same frame (white or black).

The article number composition for the Aeris Numo Comfort backrest padding easily explained.

The Aeris Numo Comfort backrest padding is also available as a retrofit accessory.

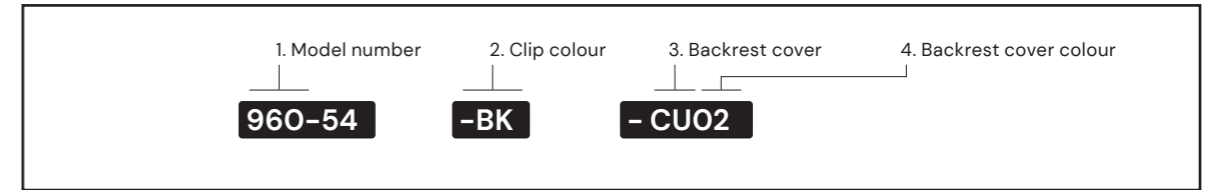

1. Model number	Article code
Backrest padding	960-54

3. Backrest cover	Article code
Recycled Post-Consumer Polyester (Cura, Gabriel)	- CU
Artificial leather(Mediflex, Monteiro)	- ME

2. Clip colour	Article code
white	- WH
black	- BK

4. Backrest cover colour	Article code
--------------------------	--------------

The colour of the backrest cover can only be selected to match the seat cover

Aeris Numo Comfort Fabric sample overview

Cura / Gabriel

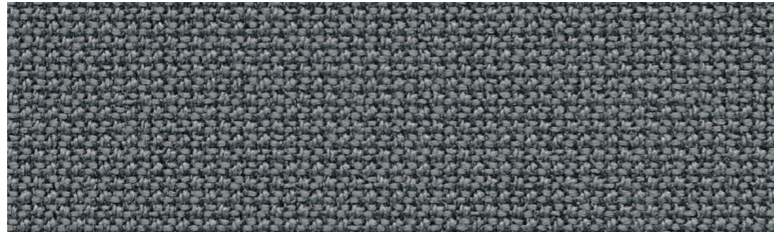

Mediflex / Monteiro

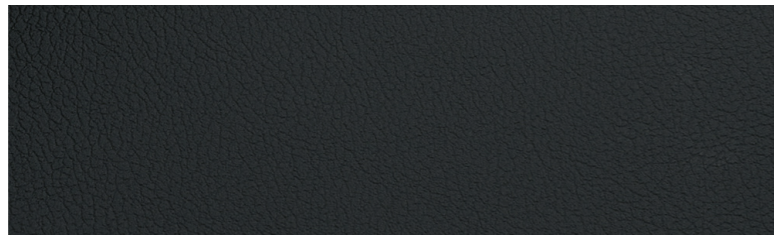

CU01, black

60111

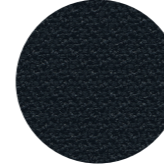

CU02, grey
melange

60110

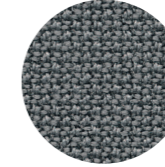

CU04, blue
melange

66167

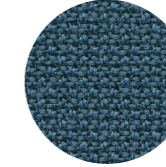

CU06, yellow
melange

62084

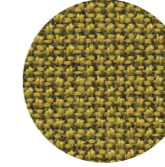

CU09, light violet
melange

64194

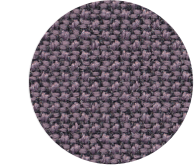

CU12, petrol blue
melange

67084

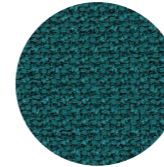

CU13, pale green
melange

68186

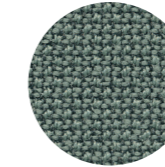

CU14, fern green
melange

68181

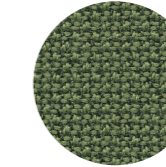

CU16, beige
melange

61168

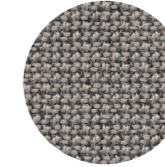

CU17, light grey
melange

60112

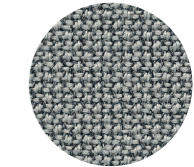

ME01, black

67796

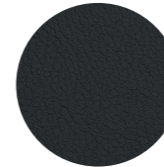

Gabriel Cura features

The Cura fabric cover is characterized by a warm, casual aesthetic that is complemented by a lively melange effect and a soft, voluminous texture.

But this material is not only visually appealing - its high stretchability enables flexible use, making it perfect for office and lounge furniture. But what makes this material special is its sustainability. As much as 98% of the material is made from recycled post-consumer polyester, which makes a significant contribution to reducing waste. In addition, the entire material is 100% recyclable and therefore contributes to a closed-loop economy.

But this material also scores highly in terms of ecological standards. The EU Ecolabel shows that it meets strict environmental criteria and is therefore an environmentally friendly choice. It also fulfills meets the requirements of STANDARD 100 by OEKO-TEX®, which means that it has been tested for possible harmful substances and is considered safe for human use.

Cura-Specifications

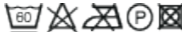
Design no.	2480/2544	
Composition	100% post-consumer recycled polyester	
Weight	g/lm 420 oz/lin.yd 55	
Width	cm 140 inches 55	
Abrasion	rubs Martindale (EN ISO 12947-2) 100.000 Double Rubs Wyzenbeek (ASTM D4157-07) (heavy duty upholstery) 100.000 ASTM D4157-07 Wyz-abrasion (heavy duty) 100k pass Abrasion test results exceeding ACT Performance Guidelines are not an indicator of product lifespan	
Pilling	scale 1-5, max. 5 - EN ISO 12945-2 ASTM D3511 Pilling pass	4-5
Light fastness	scale 1-8, max. 8 - EN ISO 105-B02 AATCC 16 Light fastness pass	5-8
Rubbing fastness	scale 1-5, max. 5 - EN ISO 105x12 (dry/wet) AATCC 8 oder 116 Dry/wet crocking	4-5/4-5 pass
Care instructions	wash or dry cleaning P(W) Cura is made of polyester which is a material suited for environments with special requirements for cleaning.  40°C shrinkage max. 1%.  60°C shrinkage max. 2%.	
Flammability	BS EN 1021 1&2 Cigarette and Match CA TB 117-2013 ASTM E 84 Class 1 Will also pass other flammability standards. Flame retardant performance is dependent upon the foam used. Contains no flame retardant chemicals.	
Environment	OEKO-TEX® STANDARD 100 EU Ecolabel	

Monteiro Mediflex features

The Monteiro cover impresses with its clear, functional appearance and is consistently designed for professional use. The understated look is high-quality and fits easily into different room and usage concepts – from functional working environments to medical and care facilities.

The material is designed for heavy use and offers excellent resistance in daily continuous use. Even with intensive use, the surface and structure remain stable, which supports a long service life and reduces maintenance requirements.

A key advantage is that it is very easy to care for and clean. The surface is easy to clean and meets the requirements of hygienically sensitive areas. At the same time, the material properties ensure pleasant seating comfort without compromising robustness.

Mediflex specifications

Weight per unit area	640 g/m² ± 5 %
Material thickness	1,00 – 1,20 mm
Composition	88 % PVC / 12 % PA
Product range	1,37 – 1,40 m
Abrasion resistance	400,000 Martindale cycles (ISO 5470-2)
Cold resistance	Cold crack resistant
Colour fastness / durability	Friction (ISO 105-X12) / Ethyl alcohol 70% Bleach (4.5% chlorine) / Acidic and alkaline sweat solutions (ISO 105-E04) / Saliva (DIN 53160-1) Artificial blood / Artificial urine / Massage oil / Hand cream
Light fastness	Artificial weathering (ISO 105-B04) Artificial light (ISO 105-B02)
Fire behaviour	FMVSS 302 / EN 1021-1 + 2 / NFPA 260 – Class 1 California Technical Bulletin 117 – Section 11MO 2020 FTP Code Part 8
Antibacterial / antifungal properties	Sanitized® (ISO 20743, ISO 846 A)
Antiviral properties	Log reduction: 75.52% (ISO 18184)
Biocompatibility	ISO 10993-10 – Tests for irritation and delayed hypersensitivity / ISO 10993-5 – In vitro cytotoxicity
Care	Easy to clean with mild detergent and a damp cloth Free from harmful substances / phthalate-free Manufactured in accordance with REACH (EC No. 1907/2006) Suitable for toys and children's products (Directive 2005/84/EC)

Notes

Subject to technical change and model modifications. Colours may vary slightly from batch to batch. Freight costs on request. The valid general terms and conditions of Aeris GmbH apply. The Price List 04/2026 renders all previous price lists invalid. No liability is taken for errors, printing errors and changes in prices or product specifications. Please note, that not all products are available in all countries. If you have any questions, please contact the Aeris team.

Price List

Aeris Numo Task

The prices for Aeris Numo Task chairs are determined by the type of frame (column, spring leg), the seat cover and the optional backrest cushion.

Aeris Numo Task with column			
Cover	Frame colour	Without backrest padding, with glides or castors. Recommended retail price in EUR excl. VAT	With backrest padding, with glides or castors. Recommended retail price in EUR excl. VAT
Recycled post-consumer polyester (Cura, Gabriel)	white, black	€ 511.76	€ 553.78
Artificial leather (Mediflex, Monteiro)	white, black	€ 520.17	€ 570.59
Aeris Numo Task with Spring strut			
Cover	Frame colour	Without backrest padding, with glides or castors. Recommended retail price in EUR excl. VAT	With backrest padding, with glides or castors. Recommended retail price in EUR excl. VAT
Recycled post-consumer polyester (Cura, Gabriel)	white, black	€ 629.41	€ 671.43
Artificial leather (Mediflex, Monteiro)	white, black	€ 637.82	€ 688.24
Backrest padding	Recommended retail price in EUR excl. VAT		
Recycled post-consumer polyester (Cura, Gabriel)	€ 57.98		
Artificial leather (Mediflex, Monteiro)	€ 66.39		

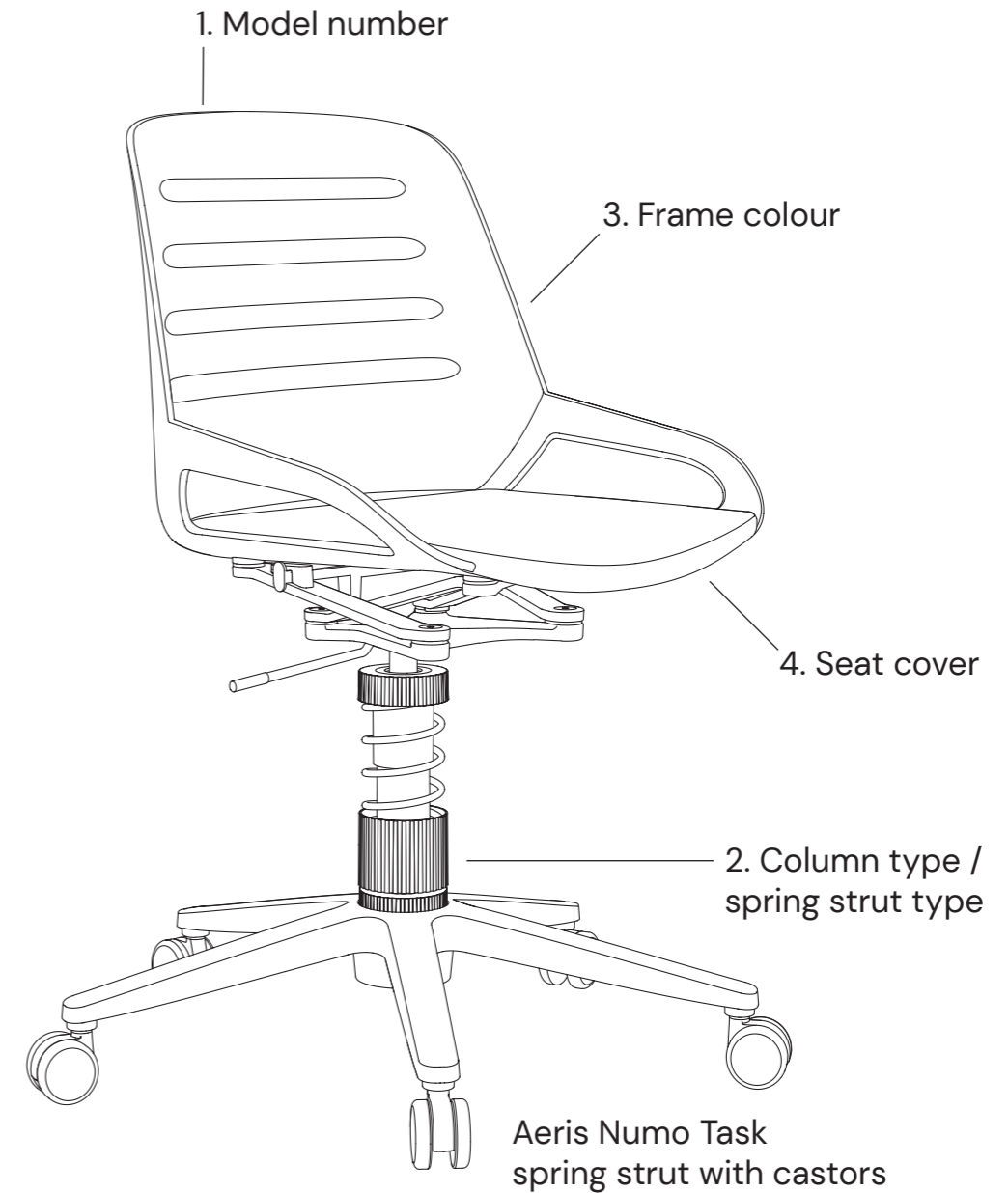

Aeris Numo Task column with castors



Aeris Numo Task column with glides



Aeris Numo Task spring strut with glides

Components of the Aeris Numo Task article number easily explained.

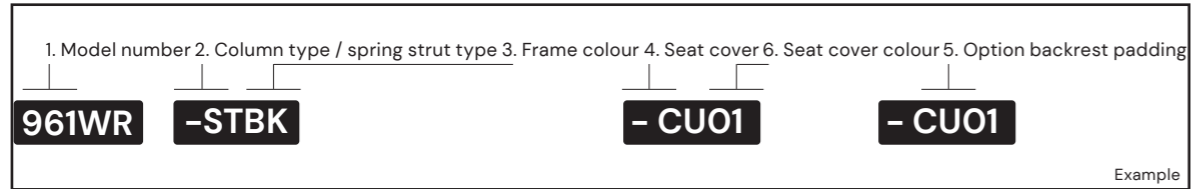

1. Model number	Article code
Column with castors	961WR
Spring strut with castors	962WR
Column with glides	961UG
Spring strut with glides	962UG

2. Column type	Article code
Standard: Body weight: 45-120 kg Seat height: 42-53 cm	- ST

2. Spring strut type	Article code
Light: Body weight: 45 - 60 kg Seat height loaded: 44-52,5 cm Seat height unloaded: 54-62,5 cm	- LI
Standard*: Body weight: 60 - 120 kg Seat height loaded 44-52,5 cm Seat height unloaded: 54-62,5 cm	- ST

3. Frame colour	Article code
white	WH
black	BK

4. Seat cover	Article code
Recycled Post-Consumer Polyester (Cura, Gabriel)	- CU
Artificial leather (Mediflex, Monteiro)	- ME

5. Backrest cover*	Article code
Recycled Post-Consumer Polyester (Cura, Gabriel)	- CU
Artificial leather (Mediflex, Monteiro)	- ME

*Optional. The colour of the backrest cover can only be selected to match the seat cover.

6. Seat cover colour	The article code (= colour number Aeris) can be found on the following page. Simply add this to the article code of the seat cover (without hyphen).			
	DIN-Norm	Column	FB Light	FB Standard
Without backrest padding		DIN 16139	DIN 16139	DIN 16139
With backrest padding		DIN 1335	DIN 1335	DIN 1335 ab 50. Percentil*

* From a height of 1,62 m for Women and 1,75 m for men.

The article number composition for the Aeris Numo Task backrest padding easily explained.

The Aeris Numo Task backrest padding is also available as a retrofit accessory.

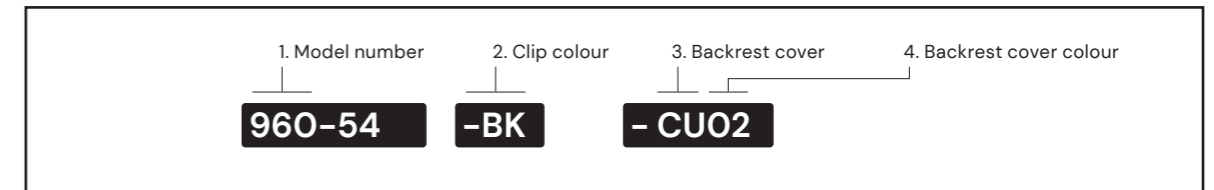

1. Model number	Article code
Backrest padding	960-54

2. Clip colour	Article code
white	- WH
black	- BK

3. Backrest cover	Article code
Recycled Post-Consumer Polyester (Cura, Gabriel)	- CU
Artificial leather (Mediflex, Monteiro)	- ME

4. Backrest cover colour	The colour of the backrest cover can only be selected to match the seat cover	
--------------------------	---	--

Aeris Numo Task Fabric sample overview

Cura / Gabriel

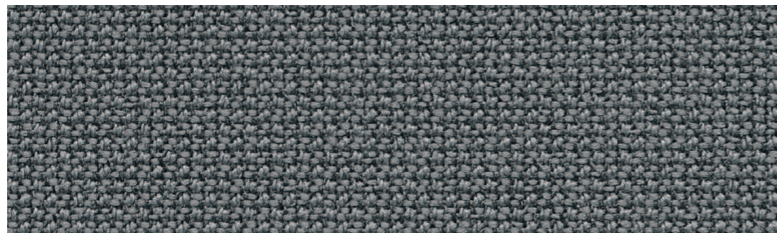

Mediflex / Monteiro

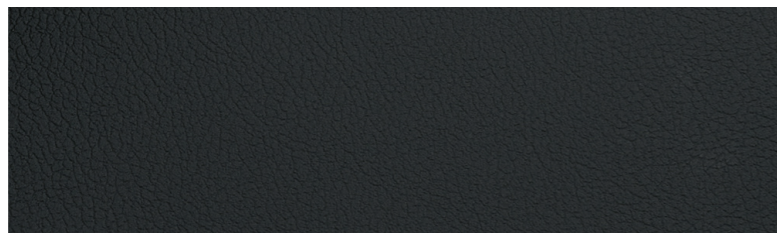

CU01, black

60111

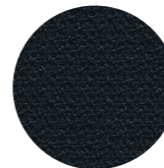

CU02, grey
melange

60110

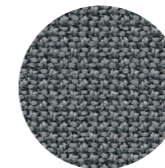

CU04, blue
melange

66167

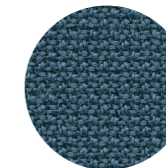

CU06, yellow
melange

62084

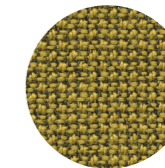

CU09, light violet
melange

64194

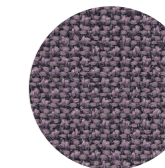

CU12, petrol blue
melange

67084

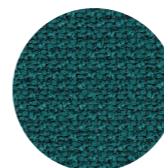

CU13, pale green
melange

68186

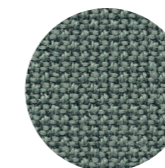

CU14, fern green
melange

68181

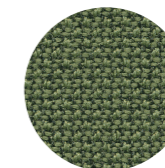

CU16, beige
melange

61168

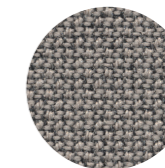

CU17, light grey
melange

60112

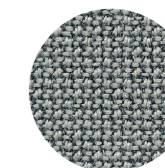

ME01, black

67796

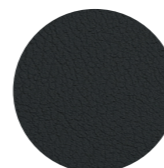

Gabriel Cura features

The Cura fabric cover is characterized by a warm, casual aesthetic that is complemented by a lively melange effect and a soft, voluminous texture.

But this material is not only visually appealing - its high stretchability enables flexible use, making it perfect for office and lounge furniture. But what makes this material special is its sustainability. As much as 98% of the material is made from recycled post-consumer polyester, which makes a significant contribution to reducing waste. In addition, the entire material is 100% recyclable and therefore contributes to a closed-loop economy.

But this material also scores highly in terms of ecological standards. The EU Ecolabel shows that it meets strict environmental criteria and is therefore an environmentally friendly choice. It also fulfills meets the requirements of STANDARD 100 by OEKO-TEX®, which means that it has been tested for possible harmful substances and is considered safe for human use.

Cura-Specifications

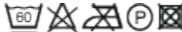
Design no.	2480/2544	
Composition	100% post-consumer recycled polyester	
Weight	g/lm 420 oz/lin.yd 55	
Width	cm 140 inches 55	
Abrasion	rubs Martindale (EN ISO 12947-2) 100.000 Double Rubs Wyzenbeek (ASTM D4157-07) (heavy duty upholstery) 100.000 ASTM D4157-07 Wyz-abrasion (heavy duty) 100k pass Abrasion test results exceeding ACT Performance Guidelines are not an indicator of product lifespan	
Pilling	scale 1-5, max. 5 - EN ISO 12945-2 ASTM D3511 Pilling pass	4-5
Light fastness	scale 1-8, max. 8 - EN ISO 105-B02 AATCC 16 Light fastness pass	5-8
Rubbing fastness	scale 1-5, max. 5 - EN ISO 105x12 (dry/wet) AATCC 8 oder 116 Dry/wet crocking	4-5/4-5 pass
Care instructions	wash or dry cleaning P(W) Cura is made of polyester which is a material suited for environments with special requirements for cleaning.  40°C shrinkage max. 1%.  60°C shrinkage max. 2%.	
Flammability	BS EN 1021 1&2 Cigarette and Match CA TB 117-2013 ASTM E 84 Class 1 Will also pass other flammability standards. Flame retardant performance is dependent upon the foam used. Contains no flame retardant chemicals.	
Environment	OEKO-TEX® STANDARD 100 EU Ecolabel	

Monteiro Mediflex features

The Monteiro cover impresses with its clear, functional appearance and is consistently designed for professional use. The understated look is high-quality and fits easily into different room and usage concepts – from functional working environments to medical and care facilities.

The material is designed for heavy use and offers excellent resistance in daily continuous use. Even with intensive use, the surface and structure remain stable, which supports a long service life and reduces maintenance requirements.

A key advantage is that it is very easy to care for and clean. The surface is easy to clean and meets the requirements of hygienically sensitive areas. At the same time, the material properties ensure pleasant seating comfort without compromising robustness.

Mediflex specifications

Weight per unit area	640 g/m² ± 5 %
Material thickness	1,00 – 1,20 mm
Composition	88 % PVC / 12 % PA
Product range	1,37 – 1,40 m
Abrasion resistance	400,000 Martindale cycles (ISO 5470-2)
Cold resistance	Cold crack resistant
Colour fastness / durability	Friction (ISO 105-X12) / Ethyl alcohol 70% Bleach (4.5% chlorine) / Acidic and alkaline sweat solutions (ISO 105-E04) / Saliva (DIN 53160-1) Artificial blood / Artificial urine / Massage oil / Hand cream
Light fastness	Artificial weathering (ISO 105-B04) Artificial light (ISO 105-B02)
Fire behaviour	FMVSS 302 / EN 1021-1 + 2 / NFPA 260 – Class 1 California Technical Bulletin 117 – Section 11MO 2020 FTP Code Part 8
Antibacterial / antifungal properties	Sanitized® (ISO 20743, ISO 846 A)
Antiviral properties	Log reduction: 75.52% (ISO 18184)
Biocompatibility	ISO 10993-10 – Tests for irritation and delayed hypersensitivity / ISO 10993-5 – In vitro cytotoxicity
Care	Easy to clean with mild detergent and a damp cloth Free from harmful substances / phthalate-free Manufactured in accordance with REACH (EC No. 1907/2006) Suitable for toys and children's products (Directive 2005/84/EC)

Notes

Subject to technical change and model modifications. Colours may vary slightly from batch to batch. Freight costs on request. The valid general terms and conditions of Aeris GmbH apply. The Price List 04/2026 renders all previous price lists invalid. No liability is taken for errors, printing errors and changes in prices or product specifications. Please note, that not all products are available in all countries. If you have any questions, please contact the Aeris team.

Price List

Aeris Muvman

The Aeris Muvman prices are determined by the column height (Standard or High) and the different seat covers.

Seat cover	Aeris Muvman Standard Recommended retail price in EUR excl. VAT	Aeris Muvman High Recommended retail price in EUR excl. VAT
Artificial leather (Poro, ATN)	€ 368.91	€ 394.12
Recycled Post-Consumer Polyester (Cura, Gabriel)	€ 385.71	€ 410.92
Artificial leather (Mediflex, Monteiro)	€ 394.12	€ 419.33
Wool blend (Select, Gabriel)	€ 394.12	€ 419.33
Microfibre (Comfort, Gabriel)	€ 402.52	€ 427.73

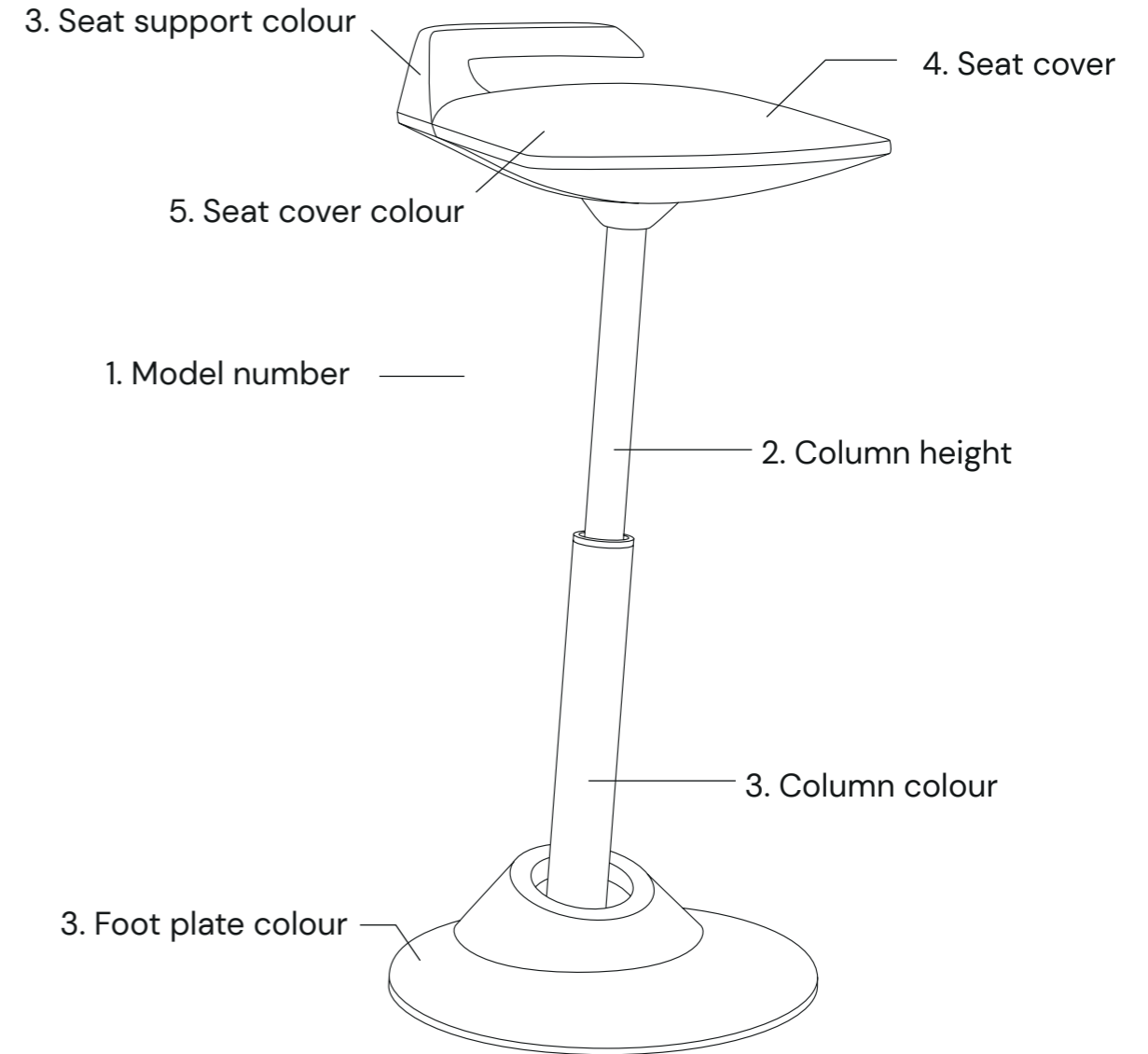

Components of the Aeris Muvman article number easily explained.

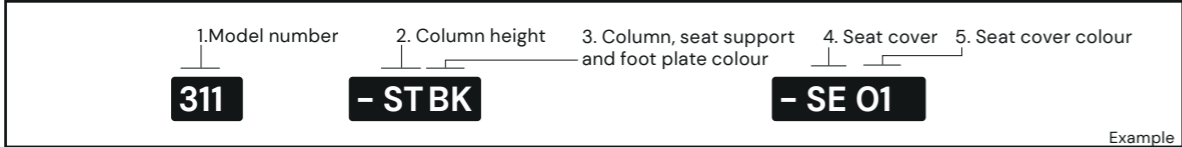

1. Model number	Article code
Muvman	311

2. Column height	Article code
Standard: Body weight: up to 120 kg Height adjustment range: 51 – 84 cm	- ST
High: Body weight: up to 120 kg Height adjustment range: 60 – 93 cm	- HI

3. Column, seat support and foot plate colour	Article code
grey	GR
black	BK

4. Seat cover	Article code
Artificial leather (Poro, ATN)	- AT
Recycled Post-Consumer Polyester (Cura, Gabriel)	- CU
Artificial leather (Mediflex, Monteiro)	- ME
Wool blend (Select, Gabriel)	- SE
Microfibre (Comfort, Gabriel)	- CM

5. Seat cover colour

Please first select one of the available seat cover colours for the Aeris Muvman. The relevant article code (Aeris colour code) can be found on the following pages. Please simply put it behind the article code of the seat cover (without hyphen).

Aeris Muvman Fabric sample overview

Select / Gabriel



Comfort / Gabriel



Cura / Gabriel

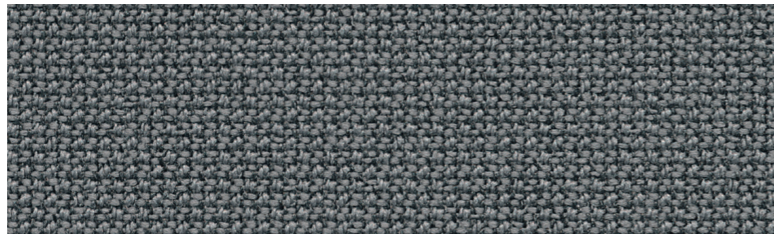

Poro / ATN

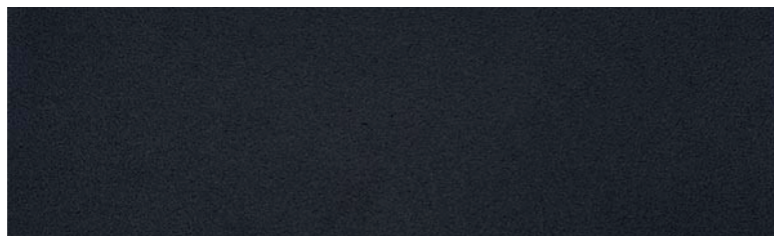

SE01, black
60999



CM01, black
0050

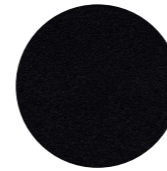

CM02, grey
1012

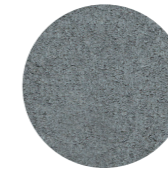

CM03, red
1414

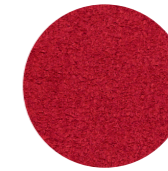

CM04, blue
66004

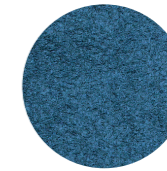

CM05, green
8397

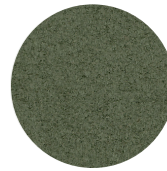

CU01, black
60111

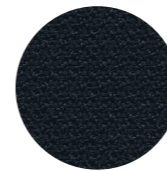

CU02, grey
melange
60110

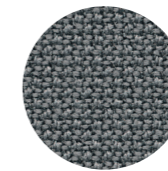

CU04, blue
melange
66167

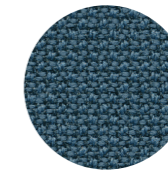

CU14, fern green
melange
68181

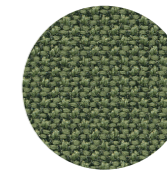

CU17, light grey
melange
60112

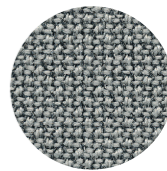

AT01, black
2127



Aeris Muvman Fabric sample overview

Mediflex / Monteiro

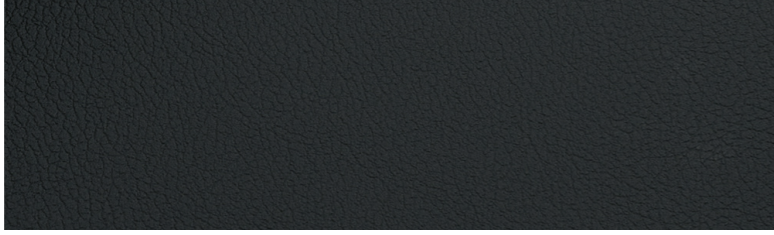

ME01, black
67796



Gabriel Select features

This impressive material boasts an elegant simplicity that is accompanied by an allround user-friendly design. With an extensive full spectrum color palette, it offers an almost endless variety of possibilities for design, making it fits perfectly with a wide variety of furnishing styles.

Thanks to its superior abrasion resistance, measured by an impressive 200,000 Martindale cycles, this material is extremely durable and resistant, even in heavy-duty environments. It is therefore an ideal choice for Highly frequented rooms such as public areas, offices or restaurants that require a durable solution.

The environmental friendliness of these materials is confirmed by the EU Ecolabel, which makes its production sustainable and environmentally friendly. It also fulfills the STANDARD 100 of OEKO-TEX®, which means that it has been tested for possible harmful substances is considered safe for human use.

Select-Specifications

Design no.	2498		
Composition	85% New Zealand wool / 15% polyamide		
Weight	g/lm 510 oz/lin.yd 16.45		
Width	cm 140 inches 55		
Abrasion	rubs martindale (EN ISO 12947-2) 200.000 ASTM D4966 Martindale (heavy duty) rubs martindale (ASTM D4966) (heavy duty upholstery) 100.000 Abrasion test results exceeding ACT Performance Guidelines are not an indicator of product lifespan		
Pilling	scale 1-5, max. 5 - EN ISO 12945-2 ASTM D4970 Pilling pass	4	
Light fastness	scale 1-8, max. 8 - EN ISO 105-B02 AATCC 16 Light fastness pass	5-8	
Rubbing fastness	scale 1-5, max. 5 - EN ISO 105x12 (dry/wet) AATCC 8 or 116 Dry/wet crocking	4-5/4-5	pass
Care instructions	dry cleaning P(S) 		
Flammability	BS EN 1021-1 Cigarette BS EN 1021-2 Match BS 5852 Part 1 O,1 Cigarette & Match, The Furniture and Furnishing Regulations 1988 BS 5852 Crib 5 IMO MSC 307(88) Annex 1 part 8 MED Certificate IMO IMO MSC 307(88) Annex 1 part 8 UK MED Certificate IMO UK CA TB 117-2013 Will also pass other flammability standards. Flame retardant performance is dependent upon the foam used. Contains no flame retardant chemicals..		
Environment	OEKO-TEX® STANDARD 100 EU Ecolabel		

Gabriel Comfort features

The high-quality fabric was specially developed for intensive use and has outstanding properties. With an impressive Martindale value of 150,000, it is extremely hard-wearing and resistant to abrasion.

Thanks to the use of carbon fibers, the fabric is permanently antistatic, which means that it hardly collects any dust and is therefore particularly easy to clean. Furthermore it is dirt-repellent and water and oil repellent, making it extremely resistant to soiling.

Another plus is its openness to diffusion, which means that the fabric enables excellent air and moisture exchange and thus counteracts the formation of mold.

Safety is a top priority with this fabric, as it is permanently fire-resistant - a property achieved by fire-retardant fibers. It therefore offers a high level of safety and protection.

For the environmentally conscious buyer, it is important to know that this fabric contains 37% recycled fibers, which contributes to the sustainable use of resources.

And to top it all off, the fabric manufacturer offers a generous 10-year guarantee against abrasion and pilling, which further reinforces confidence in the quality of this product.

The fabric also meets the requirements of the renowned STANDARD 100 by OEKO-TEX®, which means that it has been tested for harmful substances and is considered safe for human use.

Comfort-Specifications

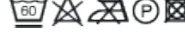
Design no.	8580		
Composition	51% polyester/37% post-consumer rec.pes./ 12% polyurethane incl. antistatic fibers and fire retardant fibers in the backside		
Weight	g/lm 385 oz/lin.yd 12.42		
Width	cm 140 inches 55		
Abrasion	rubs martindale (EN ISO 12947-2) 150.000 Abrasion test results exceeding ACT Performance Guidelines are not an indicator of product lifespan		
Pilling	scale 1-5, max. 5 - EN ISO 12945-2	5	
Light fastness	scale 1-8, max. 8 - EN ISO 105-B02	5-7	
Rubbing fastness	scale 1-5, max. 5 - EN ISO 105x12 (dry/wet)	4/4-5	
Care instructions	wash or dry cleaning P(W) most stains can be removed by brushing with a suede brush or using an eraser. or use a solution of luke-warm water and a neutral detergent. 74°C shrinkage max. 2,5%.  60°C shrinkage max. 2%. 		
Flammability	BS EN 1021 1&2 Cigarette and Match BS EN 1021-1 Cigarette ÖNORM A3800-B2-B3825-Q1 UK NF P 92-503 M3 CA TB 117-2013 Will also pass other flammability standards. Flame retardant performance is dependent upon the foam used.		
Environment	OEKO-TEX® STANDARD 100		



Gabriel Cura features

The Cura fabric cover is characterized by a warm, casual aesthetic that is complemented by a lively melange effect and a soft, voluminous texture.

But this material is not only visually appealing - its high stretchability enables flexible use, making it perfect for office and lounge furniture. But what makes this material special is its sustainability. As much as 98% of the material is made from recycled post-consumer polyester, which makes a significant contribution to reducing waste. In addition, the entire material is 100% recyclable and therefore contributes to a closed-loop economy.

But this material also scores highly in terms of ecological standards. The EU Ecolabel shows that it meets strict environmental criteria and is therefore an environmentally friendly choice. It also fulfills the requirements of STANDARD 100 by OEKO-TEX®, which means that it has been tested for possible harmful substances and is considered safe for human use.

Cura-Specifications

Design no.	2480/2544	
Composition	100% post-consumer recycled polyester	
Weight	g/lm 420 oz/lin.yd 55	
Width	cm 140 inches 55	
Abrasion	rubs Martindale (EN ISO 12947-2) 100.000 Double Rubs Wyzenbeek (ASTM D4157-07) (heavy duty upholstery) 100.000 ASTM D4157-07 Wyz-abrasion (heavy duty) 100k pass Abrasion test results exceeding ACT Performance Guidelines are not an indicator of product lifespan	
Pilling	scale 1-5, max. 5 - EN ISO 12945-2 ASTM D3511 Pilling pass	4-5
Light fastness	scale 1-8, max. 8 - EN ISO 105-B02 AATCC 16 Light fastness pass	5-8
Rubbing fastness	scale 1-5, max. 5 - EN ISO 105x12 (dry/wet) AATCC 8 oder 116 Dry/wet crocking	4-5/4-5 pass
Care instructions	wash or dry cleaning P(W) Cura is made of polyester which is a material suited for environments with special requirements for cleaning.  40°C shrinkage max. 1%.  60°C shrinkage max. 2%.	
Flammability	BS EN 1021 1&2 Cigarette and Match CA TB 117-2013 ASTM E 84 Class 1 Will also pass other flammability standards. Flame retardant performance is dependent upon the foam used. Contains no flame retardant chemicals.	
Environment	OEKO-TEX® STANDARD 100 EU Ecolabel	

Monteiro Mediflex features

The Monteiro cover impresses with its clear, functional appearance and is consistently designed for professional use. The understated look is high-quality and fits easily into different room and usage concepts – from functional working environments to medical and care facilities.

The material is designed for heavy use and offers excellent resistance in daily continuous use. Even with intensive use, the surface and structure remain stable, which supports a long service life and reduces maintenance requirements.

A key advantage is that it is very easy to care for and clean. The surface is easy to clean and meets the requirements of hygienically sensitive areas. At the same time, the material properties ensure pleasant seating comfort without compromising robustness.

Mediflex specifications

Weight per unit area	640 g/m ² ± 5 %
Material thickness	1,00 – 1,20 mm
Composition	88 % PVC / 12 % PA
Product range	1,37 – 1,40 m
Abrasion resistance	400,000 Martindale cycles (ISO 5470-2)
Cold resistance	Cold crack resistant
Colour fastness / durability	Friction (ISO 105-X12) / Ethyl alcohol 70% Bleach (4.5% chlorine) / Acidic and alkaline sweat solutions (ISO 105-E04) / Saliva (DIN 53160-1) Artificial blood / Artificial urine / Massage oil / Hand cream
Light fastness	Artificial weathering (ISO 105-B04) Artificial light (ISO 105-B02)
Fire behaviour	FMVSS 302 / EN 1021-1 + 2 / NFPA 260 – Class 1 California Technical Bulletin 117 – Section 11MO 2020 FTP Code Part 8
Antibacterial / antifungal properties	Sanitized® (ISO 20743, ISO 846 A)
Antiviral properties	Log reduction: 75.52% (ISO 18184)
Biocompatibility	ISO 10993-10 – Tests for irritation and delayed hypersensitivity / ISO 10993-5 – In vitro cytotoxicity
Care	Easy to clean with mild detergent and a damp cloth Free from harmful substances / phthalate-free Manufactured in accordance with REACH (EC No. 1907/2006) Suitable for toys and children's products (Directive 2005/84/EC)

ATN Poro features

The ideal cover for easy cleaning - the Poro faux leather impresses with its beautiful and even surface embossing and has a very good grip. The black faux leather cover makes this chair model a robust companion for many years.

Poro-Specifications

Parameter	Dimension	Method	Value
Weight	g/qm	DIN EN ISO 2286-2	650 ± 50
Fabric (cotton, PES)	g/qm	DIN EN ISO 2286-2	80 - 90
Thickness	mm	DIN EN ISO 2286-3	0,95 - 1,10
Tensile strength - Length - Width	N/5cm	DIN EN ISO 1421/V1	≥ 200 ≥ 150
Tear propagation force - length - width	N	DIN 53363	≥ 25 ≥ 40
- length - width	N	DIN EN ISO 4674	≥ 20 ≥ 15
Adhesive strength - length - width	N/5cm	DIN EN ISO 2411	≥ 30 ≥ 30
Burning behaviour	mm/min	DIN 75200 FMVSS 302 ISO 3795 ÖNORM B3825 DIN/ BS EN 10211 + 2 IMO 2010 FTP Code Part 8 NFP 92-503 Franz.Norm	≤ 100 ≤ 100 passed flame retardant (B1) no ignition no ignition no ignition M2
Rubbing fastness - dry - wet		DIN EN ISO 105-X12	i. O. i. O.
Abrasion test (Martindale)	Cykl.	DIN EN ISO 12947-2 BS 5690	≥ 120.000
Light fastness	Blue scale	DIN EN ISO 105-B06	≥ 6
Flexibility Room temp.	Cykl.	DIN EN ISO 32100	≥ 100.000

Notes

Subject to technical change and model modifications. Colours may vary slightly from batch to batch. Freight costs on request. The valid general terms and conditions of Aeris GmbH apply. The Price List 04/2026 renders all previous price lists invalid. No liability is taken for errors, printing errors and changes in prices or product specifications. Please note, that not all products are available in all countries. If you have any questions, please contact the Aeris team.

Price List

Aeris Muvman

Industry

The Aeris Muvman Industry prices are determined by the different column heights (Standard or High).

Seat upholstery	Aeris Muvman Industry Standard Recommended retail price in EUR excl. VAT	Aeris Muvman Industry High Recommended retail price in EUR excl. VAT
Integral foam	€ 335.29	€ 360.50

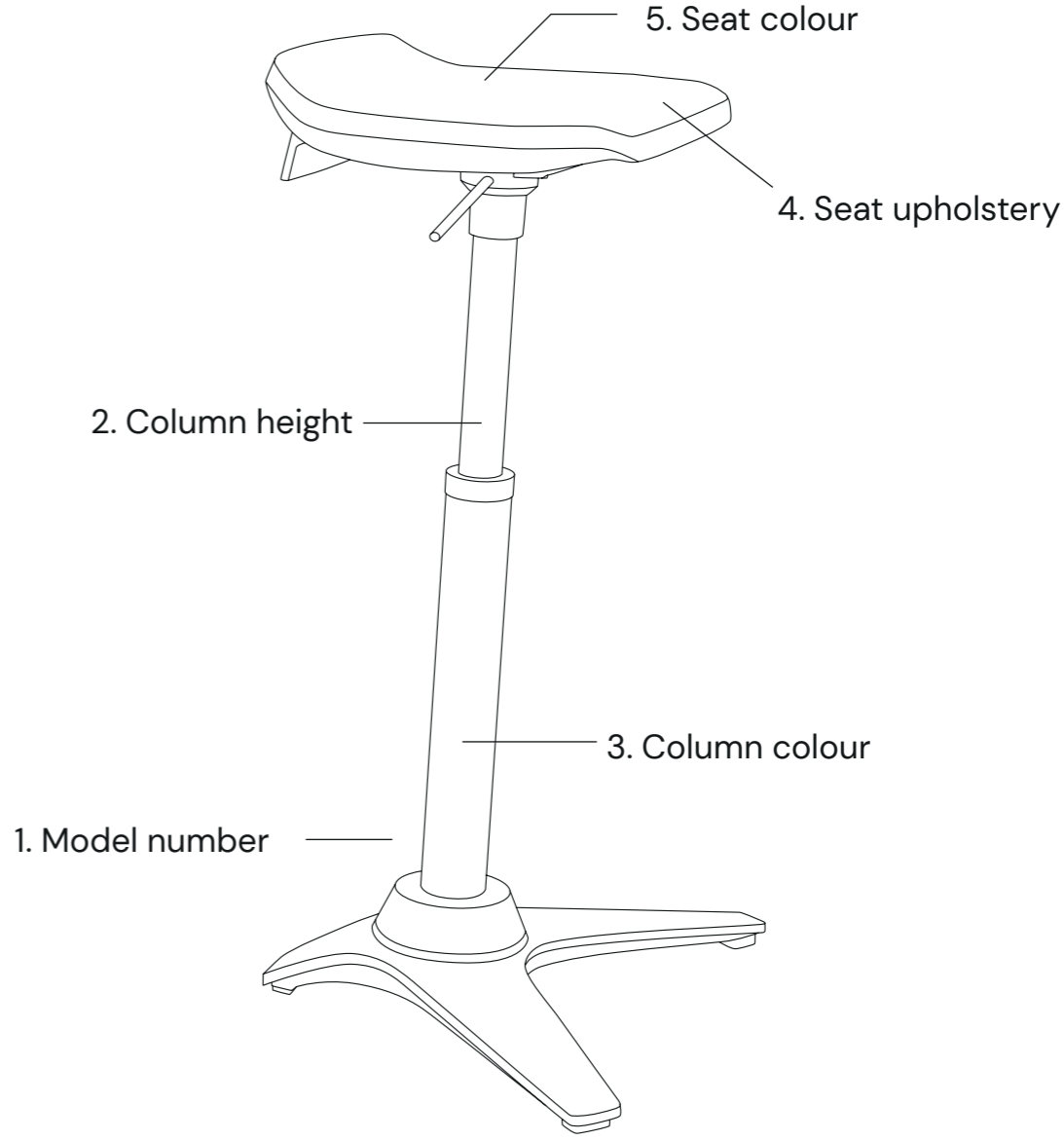

Components of the Aeris Muvman Industry article number easily explained.

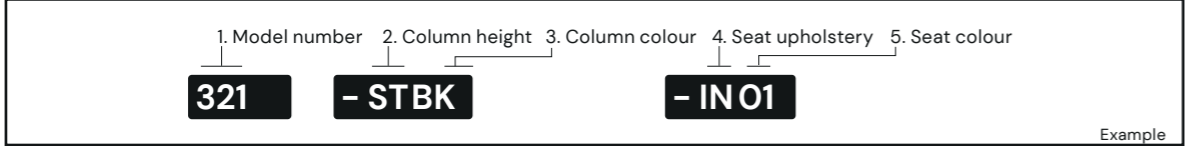

1. Model number	Article code
Muvman Industry	321

3. Column colour	Article code
black	BK

2. Column height	Article code
Standard: Body weight: up to 120 kg Height adjustment range: 51 – 84 cm	- ST
High: Body weight: up to 120 kg Height adjustment range: 60 – 93 cm	- HI

4. Seat upholstery	Article code
Integral foam	- IN

5. Seat colour	Article code
black	01

Notes

Subject to technical change and model modifications. Colours may vary slightly from batch to batch. Freight costs on request. The valid general terms and conditions of Aeris GmbH apply. The Price List 04/2026 renders all previous price lists invalid. No liability is taken for errors, printing errors and changes in prices or product specifications. Please note, that not all products are available in all countries. If you have any questions, please contact the Aeris team.

Price List

Aeris Muvmat

The Aeris Muvmat prices are determined by the different options of covers (with or without cover).

Cover	Aeris Muvmat Recommended retail price in EUR excl. VAT
without cover	€ 167.23
with cover	€ 200.84

Covers are also available separately as accessories.

Accessories	Recommended retail price in EUR excl. VAT
Pure Black cover	€ 41.18
Topography 2.0 cover	€ 41.18
Leaf Art cover	€ 41.18
Jungle cover	€ 41.18
Lily cover	€ 41.18
Flora cover	€ 41.18
Fall cover	€ 41.18

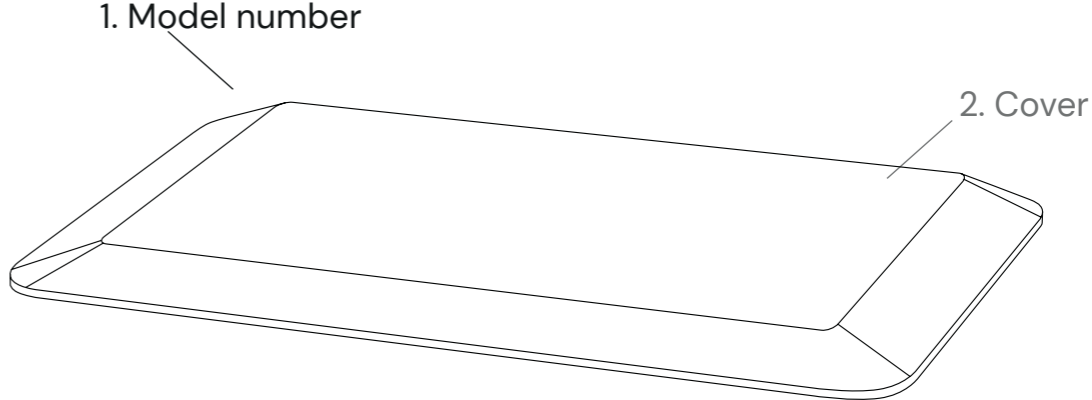

Components of the Aeris Muvmat article number easily explained.

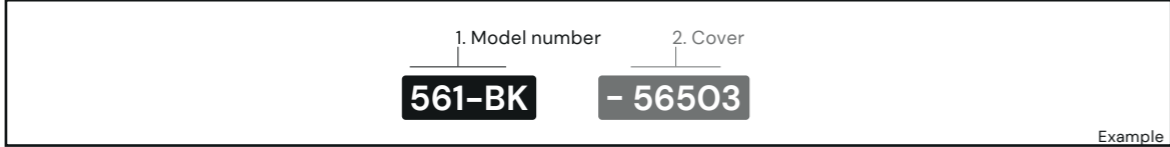

1. Model number	
	Article code
Without cover	560-BK
With cover	561-BK

2. Cover (Only for model 561-BK with cover)	
	Article code
Pure Black	- 56503
Topography 2.0	- 56504
Leaf Art	- 56505
Jungle	- 56506
Lily	- 56507
Flora	- 56508
Fall	- 56509

Article number Aeris Muvmat accessories:

Accessories	
	Article code
Pure Black cover	56503
Topography 2.0 cover	56504
Leaf Art cover	56505
Jungle cover	56506
Lily cover	56507
Flora cover	56508
Fall cover	56509

Notes

Subject to technical change and model modifications. Colours may vary slightly from batch to batch. Freight costs on request. The valid general terms and conditions of Aeris GmbH apply. The Price List 04/2026 renders all previous price lists invalid. No liability is taken for errors, printing errors and changes in prices or product specifications. Please note, that not all products are available in all countries. If you have any questions, please contact the Aeris team.

Price list Aeris Active Office Desk

Aeris Active Office Desk	
Frame colour	RRP EUR excl. VAT.
white, black	€ 1343.70

Accessories	RRP EUR excl. VAT
Cable management black	€ 74.79
Cable management white	€ 74.79
Electric set black	€ 116.81
Electric set white	€ 116.81

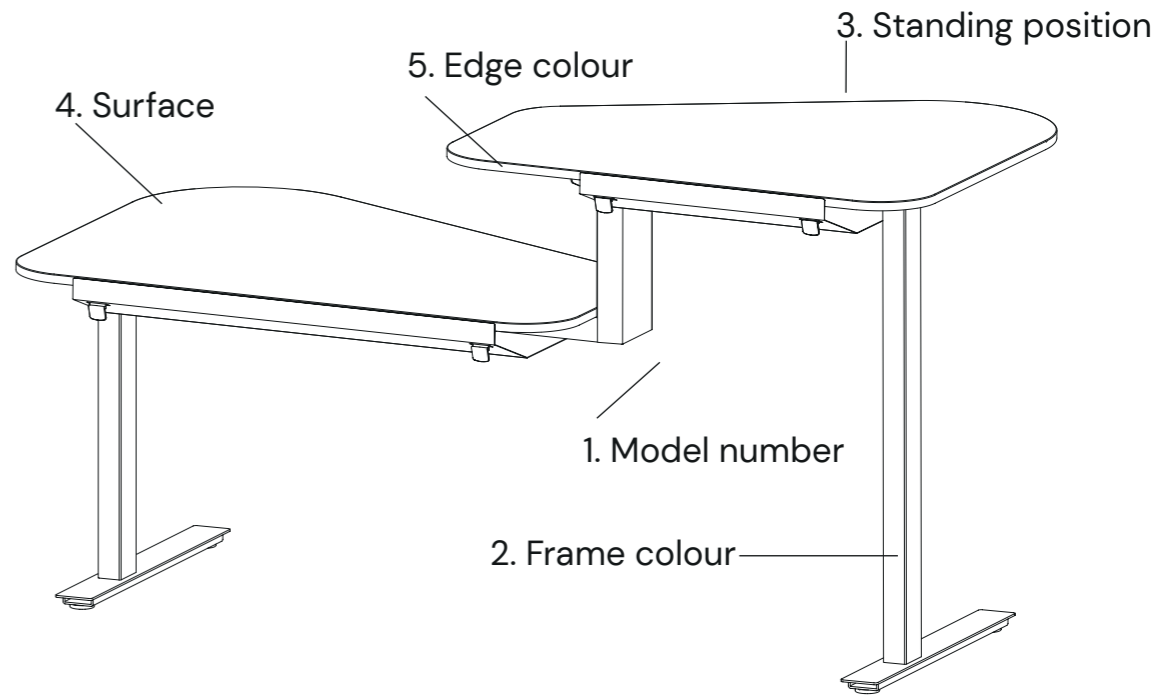

The article number composition of the Aeris Active Office Desk simply explained.



1. Model number	Article code
Active Office Desk	P-591

2. Frame colour	Article code
White	- WH
Black	- BK

3. Standing table position	Article code
Standing position left	- LI
Standing position right	- RE

4. Surface	Article code
White	WH
Black*	BK
Natural oak**	EI

* Not combinable with the edge colour white.
 **For a surface in natural oak, the edge colour is based on the selected frame colour.

5. Edge colour	Article code
White	WH
Black	BK

The article number composition of the Aeris Active Office Desk accessories simply explained.

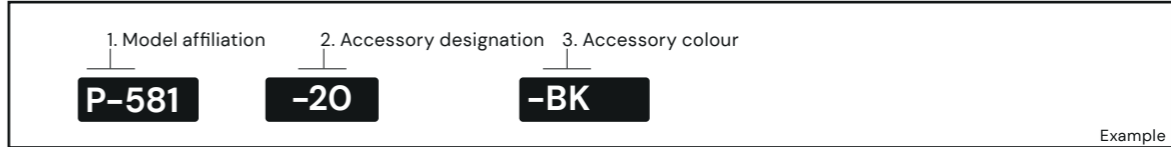

1. Model affiliation	Article code
Aeris Active Office Desk	P-581

2. Accessory designation	Article code
Cable management	- 20
Electric set	- 40

3. Accessory colour	Article code
White	- WH
Black	- BK

Aeris Active Office Edge colours + frame colours

Frame colour



Frame in powder-coated steel.

Surfaces and Edge colours

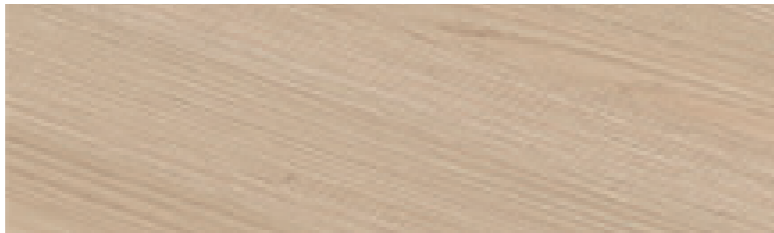
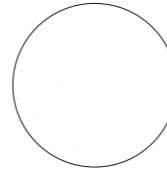
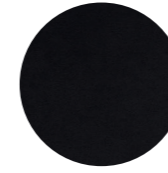

Table top made of robust, melamine-coated chipboard.
Width of table top for standing: 106 cm
Width of table top for sitting: 122 cm

White



Black



Oak/
White



Oak/
Black



Black/
Black

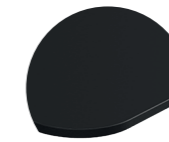

White/
White



White/
Black



Notes

Subject to technical change and model modifications. Colours may vary slightly from batch to batch. Freight costs on request. The valid general terms and conditions of Aeris GmbH apply. The Price List 04/2026 renders all previous price lists invalid. No liability is taken for errors, printing errors and changes in prices or product specifications. Please note, that not all products are available in all countries. If you have any questions, please contact the Aeris team.