

Price List

Aeris Swoppster

Seat cover	Frame Colour	Aeris Swoppster Recommended retail price in EUR excl. VAT
Polyester (Harlequin, Gabriel)	white	€ 276.47

Slip covers are also available separately as accessories.

Accessories	Recommended retail price in EUR excl. VAT
Slip cover (grey, pink, blue, green)	€ 41.18

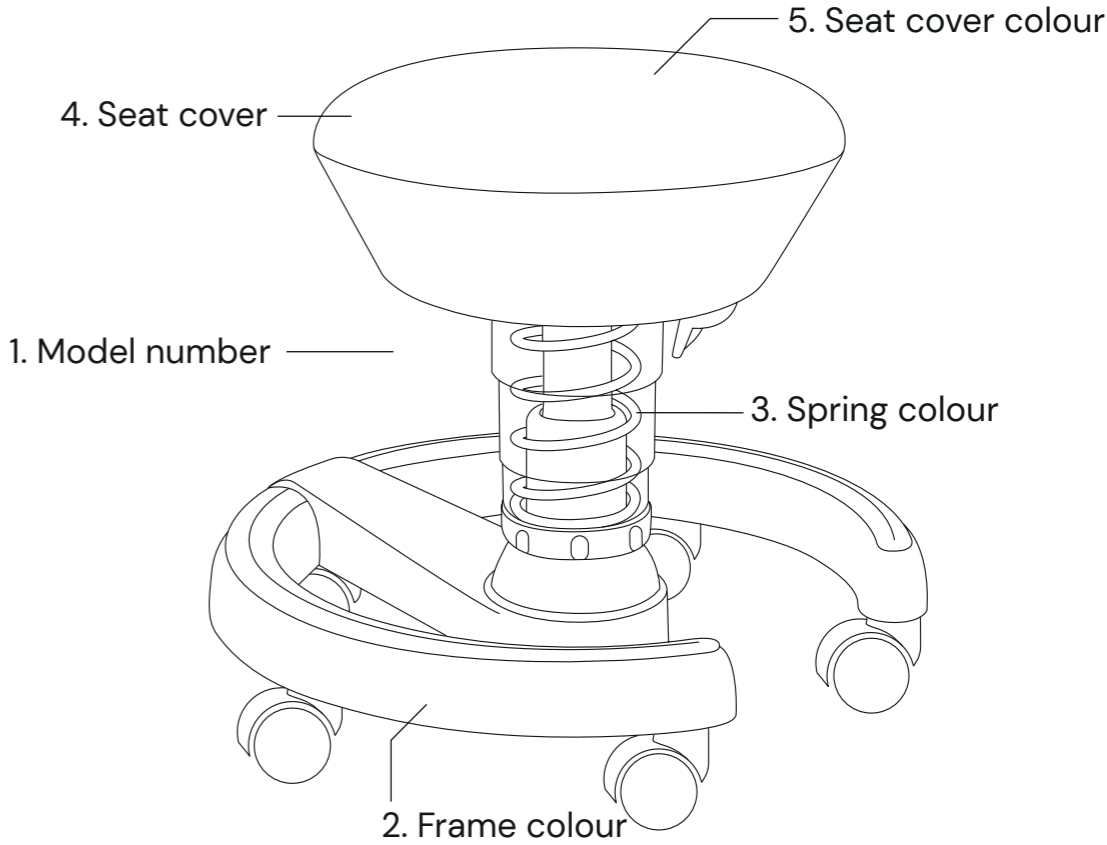

Components of the Aeris Swoppster article number easily explained.



1. Model number	Article code
Swoppster	120

2. Frame colour	Article code
white	- WH

3. Spring colour	Article code
white (only with white frame)	- WH

4. Seat cover	Article code
Polyester (Harlequin, Gabriel)	- HQ

5. Seat cover colour

Please first select the seat cover colour for the Aeris Swoppster. The relevant article code (Aeris colour code) can be found on the following pages. Simply put it behind the article code of the seat cover (without hyphen).

Article number Aeris Swoppster accessories

Accessories	Article number
Grey slip cover	125 - HQ02
Pink slip cover	125 - HQ03
Blue slip cover	125 - HQ04
Green slip cover	125 - HQ05

Aeris Swoppster Fabric sample overview

Harlequin, Gabriel

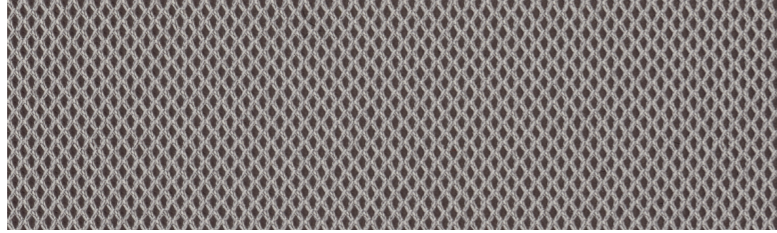

HQ02, grey
61188

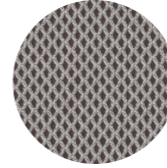

HQ03, pink
65117

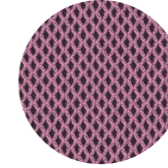

HQ04, blue
66141

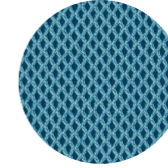

HQ05, green
68111

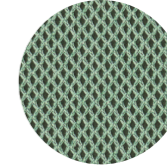

Gabriel Harlequin features

Made from 100% recyclable polyester, 23% of which is post-consumer recycled polyester, the Harlequin fabric cover is not only environmentally friendly but also durable. Its simple and streamlined appearance cuts a fine figure in any child's room.

In addition, the fabric fulfils important environmental standards such as the EU Ecolabel and STANDARD 100 by OEKO-TEX®, which means that it has been tested for harmful substances and found to be harmless.

Harlequin-Specifications

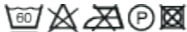
Design-Nr.	8707
Composition	77% polyester / 23% post-consumer recycled polyeste
Weight	g/lm 510 oz/lin.yd 16,45
Width	cm 160 inches 63
Abrasion	rubs martindale (EN ISO 12947-2) 100.000 double rubs wyzenbeek (ASTM D4157) (heavy duty upholstery) 100.000
Pilling	scale 1-5, max. 5 - EN ISO 12945-2 5 ASTM D3511 Pilling pass
Light fastness	scale 1-8, max. 8 - EN ISO 105-B02 5-7 AATCC 16 Light fastness pass
Rubbing fastness	scale 1-5, max. 5 - EN ISO 105x12 (dry/wet) 4-5/4-5
Care instructions	wash or dry cleaning P(W). Harlequin is made of polyester which is a material suited for environments with special requirements for cleaning.  40°C shrinkage max. 4,0%.  60°C shrinkage max. 5,0%.
Flammability	BS EN 1021 1&2 Cigarette and Match CA TB 117-2013 Will also pass other flammability standards. Flame retardant performance is dependent upon the foam used. Contains no flame retardant chemicals.
Environment	OEKO-TEX® STANDARD 100 EU Ecolabel Cradle to Cradle Certified® Bronze

Notes

Subject to technical change and model modifications.
Colours may vary slightly from batch to batch. Freight costs on request. The valid general terms and conditions of Aeris GmbH apply. The Price List 04/2026 renders all previous price lists invalid. No liability is taken for errors, printing errors and changes in prices or product specifications. Please note, that not all products are available in all countries. If you have any questions, please contact the Aeris team.